

► Simple, Reliable and Accurate

- Completely Automatic Operation
- Easy Adjustment and Maintenance
- Quality Approved Materials
- World Wide Support

► CLA-VAL SERIES 210 Main Function

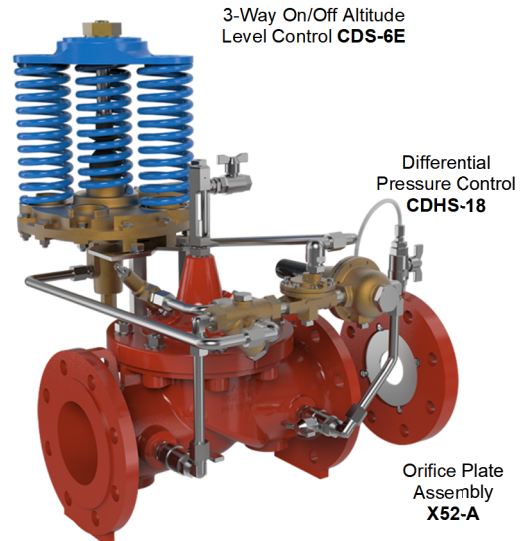
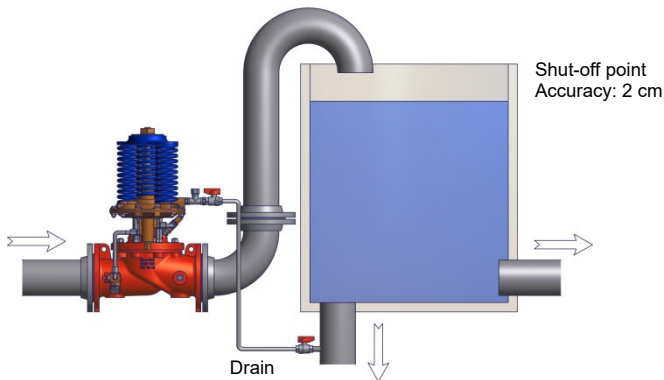

The CLA-VAL SERIES 210 On/Off Altitude Level Control Valve controls the high water level in a reservoir or closed tank without the need for floats or other devices. It is a non-throttling valve that remains fully open until the shut-off point is reached.

► CLA-VAL 210-21 Typical Application

The CLA-VAL 210-21 is typically designed for closed tanks where water is withdrawn through a separate line. The desired water level is set by adjusting the spring force. The pilot control operates on the differential in forces between a spring load and the water level in the reservoir. The CLA-VAL 210-21 is typically installed when feeding must be limited to a maximum flow rate.

Make your valve even Better!

LFS Option?	<u>Control</u> Low flows or night flows
KO Option?	<u>Extend</u> valve life with Anti-Cavitation trim
KG1 Option?	<u>Use</u> stem cleaning for harsh water
Maintenance?	<u>Check</u> on periodic maintenance
Environment?	<u>Adapt</u> to high temperatures or frost risk
Security?	<u>Add</u> hydraulic safety back-up to your valve
Protection?	<u>Remove</u> excessive system overpressures
Corrosion?	<u>Protect</u> your valve with upgraded materials

Not just Products but Solutions: contact CLA-VAL!

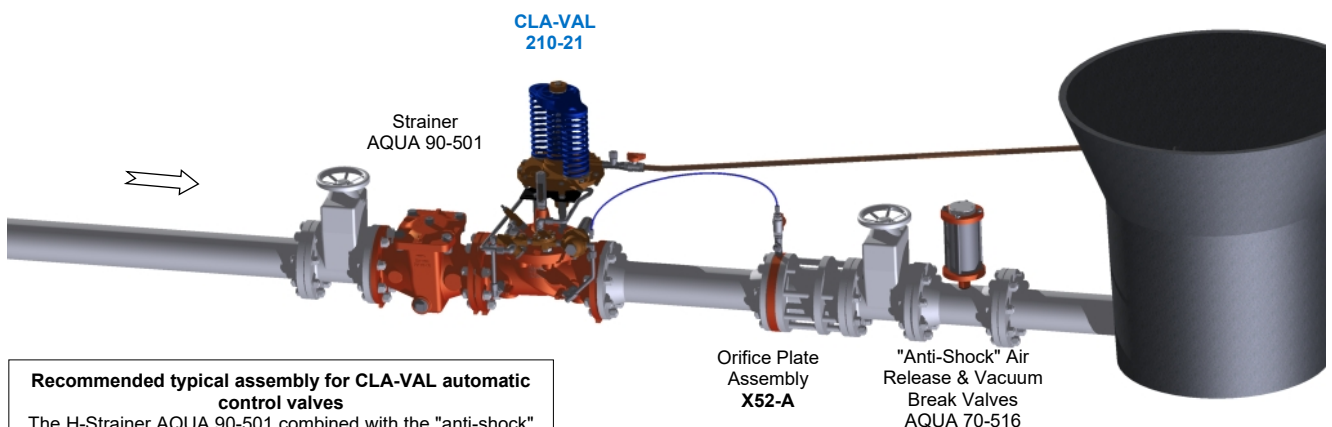

Recommended typical assembly for CLA-VAL automatic control valves

The H-Strainer AQUA 90-501 combined with the "anti-shock" air release & vacuum break valve AQUA 70-516 are added system products for the best CLA-VAL regulation.