



CLA-VAL D22

Electronic Valve Controller

User Manual





Table of Contents

1 Introduction	9
1.1 Precautions Before Starting	9
1.2 Troubleshooting	9
1.2.1 Nothing on the Display	9
1.2.2 An Input or Variable is Displayed in Red, Orange or Blue	9
1.2.3 Issue with the Behaviour of the ValvApps™	9
1.3 General Disclaimer	9
1.4 Environmental Protection	9
1.5 Typography	9
2 Electrical & Mechanical Details	10
2.1 Technical Characteristics	10
2.2 Mechanical Details	11
2.2.1 Junction Board Internal Connections	12
2.2.2 Junction Box Cable Glands / Sizes / Locations	13
2.2.3 Cover Part	15
2.3 Physical Mounting	16
2.3.1 Overall Dimensions	16
2.3.2 Bolt Pattern	19
2.4 Hardware Inputs/Outputs (I/O)	20
2.5 Wiring Analog Inputs for 4-20 mA Sensors	21
2.5.1 2-wire 4-20 mA Sensor (Loop Power)	21
2.5.1.1 2-wire (Externally Powered)	21
2.5.1.2 2-wire (Internally Powered)	22
2.5.2 4-wire 4-20 mA Sensor	23
2.5.2.1 4-wire (Externally Powered)	23
2.5.2.2 4-wire (Internally Powered)	24
2.6 Wiring Digital Inputs	24
2.6.1 Mechanical Relay	25
2.6.2 NPN Transistor	25
2.7 Outputs Solenoids	25
2.8 Power Supply	26
2.8.1 DC Input Power	26
2.8.2 Autonomous Power Supply	26
2.8.3 Alternative Power Supplies	27
2.8.3.1 Solar Panel	27
2.9 Wiring Troubleshooting	27
3 Navigation	27



3.1	Color Convention	27
3.2	Basic Button Functionality.....	28
3.2.1	Button Descriptions	28
3.2.2	Short Click - Less than 1 Seconds.....	28
3.2.3	Extended Click - More than 3 Seconds ("Home/Ok" Button Only)	29
3.3	Information Screens	30
3.3.1	Screens Description	30
3.3.1.1	"Schematics"	30
3.3.1.2	"Inputs"	31
3.3.1.3	"Output"	31
3.3.1.4	"Display Panel"	31
3.4	Configuration Tabs	32
3.4.1	"Configure Inputs" Menu	32
3.4.2	"Configure Outputs" Menu	34
3.4.3	Configure "Variables" menu	35
3.4.4	"Valve Configuration" Menu	35
3.4.4.1	Valve Configuration - "PID" Menu	36
3.4.4.1.1	"General" Tab	37
3.4.4.1.2	"Input" Tab	38
3.4.4.1.3	"Output" Tab	38
3.4.4.1.4	"Adjustment" Tab	39
3.4.4.1.5	"Zoning" Tab	40
3.4.4.1.6	"R/T View" Tab	40
3.4.4.2	Valve Configuration - "ValveFlow" Menu	41
3.4.4.2.1	"Valve" Tab	41
3.4.4.2.2	"Manage Table" Tab	42
3.4.4.2.3	"Input" and "Output" Tab	42
3.4.4.3	Valve Configuration - "Control Curve" Menu	42
3.4.4.3.1	"General" Tab	43
3.4.4.3.2	"Activation" Tab (only for Calendar & Periodic Activation)	43
3.4.4.3.3	"In/Out" Tab	44
3.4.4.3.4	"Adjustment" Tab	44
3.4.4.3.5	"R/T View" Tab	45
3.4.4.4	Valve Configuration - "Totalizer" Menu	45
3.4.4.5	Valve Configuration - "Actions" Menu	46
3.4.4.6	Valve Configuration - "Averagers" Menu	47
3.4.4.6.1	"General" Tab	47
3.4.4.6.2	"Configure" Tab	47
3.4.4.7	Valve Configuration - "Signal Retransmission" Menu	48
3.4.5	"Settings" Menu	48
3.4.5.1	"Information" Page	48
3.4.5.1.1	"Identification" Tab	48
3.4.5.1.2	"Version" Tab	49
3.4.5.1.3	"System Info" Tab	49



3.4.5.1.4	"Libraries" Tab	49
3.4.5.2	"Application Management" Page	50
3.4.5.2.1	"Backup Application"	50
3.4.5.2.2	"Restore Application"	50
3.4.5.2.3	"Export Application"	51
3.4.5.2.4	"Import Application"	52
3.4.5.3	"Time & Region" Page	53
3.4.5.3.1	"Time Zone" Tab	53
3.4.5.3.2	"Data and Time" Tab	53
3.4.5.3.3	"Language" Tab	53
3.4.5.4	"Logging" Page	54
3.4.5.4.1	"Configuration"	54
3.4.5.4.2	"Export"	55
3.4.5.5	"Unit Management" Page	55
3.4.5.6	"Connectivity" Page	55
3.4.5.6.1	"Modem Connectivity" Page	56
3.4.5.6.2	"LAN"	58
3.4.5.6.3	"Remote Recopy" page	58
3.4.5.6.4	"Modbus"	61
3.4.5.6.5	"Remote Access"	63
3.4.5.6.6	"Cloud Storage – Link2Valves"	63
3.4.5.6.7	"Cloud Storage - Link2Valves Gateway"	64
3.4.5.6.8	"Cloud Storage - MQTT"	65
3.4.5.6.9	"Wireless"	67
3.4.5.6.10	"Display"	67
3.4.5.6.11	"Security"	67
3.4.5.6.12	"Reboot"	68
3.4.5.6.13	"Advanced" Settings Page	68
3.5	In-Menu "Navigation"	70
3.5.1	Keyboard Functionality	70
3.5.2	Numeral Selection	71
3.5.3	Drop-Down Menu	72
4	Specific Features	72
4.1	Add Inputs manually	72
4.2	Custom Scaling	73
4.3	e-Lift autocalibration	73
4.4	Input Filtering	74
4.5	Remote Configuration	74
4.5.1	Register the Electronic Controller on Link2Valves	75
4.5.2	Connect to Link2Valves	75
4.6	HTTPS Peering via L2V	76
5	Appendix: Modbus Interface	79
5.1	Modbus Protocol	79



5.2	Standard Modbus Interface.....	79
5.2.1	Discrete Input Contacts.....	79
5.2.2	Discrete Input Contacts.....	79
5.2.3	Analog Input Registers.....	80
5.2.4	Holding Registers.....	81
6	Appendix: Modbus Interface for Various Slave Sensors	85
6.1	Cla-Val e-Drive-34 Actuator	85
6.1.1	Interfacing an e-Drive-34 Actuator to the Electronic Valve Controller	85
6.1.2	Calibrate an e-Drive-34 Actuator from the Electronic Valve Controller	88
6.2	Sensor Interface Definition File.....	89
6.2.1	".ID" Section	90
6.2.2	".Channels" Section	90
6.2.3	".Readrequest" Section.....	91
6.2.4	".Writerequest" Section	91
6.3	Adding Sensor Into the Electronic Valve Controller	91
7	Appendix: Engine UPDATE Information.....	94
7.1	Since Release 1.8.4 (17.10.2016)	94
7.1.1	Centralized Unit Configuration.....	94
7.1.2	Latching Solenoid Support.....	94
7.1.3	Language Support: French	94
7.2	Since Release 1.9.0 (06.06.2017)	95
7.2.1	Configuration Wizard	95
7.2.2	MODBUS Override via UI / MODBUS Debugger	97
7.2.2.1	Control Curve Navigation Improvement.....	98
7.2.2.2	Automatic Output Conversion.....	98
7.2.2.3	DP Metering	98
7.2.2.4	Remove "!Actions!".....	99
7.2.3	Bug Fixes	99
7.3	Since Release 2.0.1 (19.02.2018)	99
7.3.1	Closed Loop Critical Point Pressure Management.....	99
7.3.2	Integral and Derivative Parameters for PID	100
7.3.3	DP Metering on D12	100
7.3.3.1	Input Calibration Menu	100
7.3.3.2	DPM - Add Custom Table.....	100
7.4	Since Release 2.1.0 (20.03.2018)	100
7.4.1	Possibility to Add Control Curve on the Fly	100
7.4.2	Initial Value for Totalizer Function	101
7.4.3	Initial Value for a Counter Digital Input	101
7.4.4	Modbus - Integer Values Table and Addressing.....	101
7.4.4.1	Closed Loop Critical Point Pressure Management.....	101
7.5	Since Release 2.2.0 (03.07.2018)	102



7.5.1	Internal Variable Available Into Modbus Tale	102
7.5.2	Bug Correction	102
7.5.2.1	ValvApps Remote Backup (Communication).....	102
7.6	Since Release 2.3.1 (26.10.2018)	102
7.6.1	e-Drive-34 Full Integration (via Modbus)	102
7.6.1.1	Signal Interface	103
7.6.2	Calibration	105
7.6.3	Interface for Generic Modbus Sensors	106
7.6.4	PID	108
7.6.4.1	Multi-Zone Tuning	108
7.6.4.2	Increase Deadband Decimal	108
7.6.4.3	Logfile Date-Time Format.....	109
7.6.4.4	Communication Data Consumption Optimization	109
7.6.4.5	Wizzard Tool	109
7.6.5	Bug Correction	109
7.6.5.1	The Use of the «@» Character.....	109
7.7	Since Release 2.4.0 (08.02.2019)	110
7.7.1	WiFi Communication Capability	110
7.7.1.1	Setting up the WiFi Interface on the D22 Controller	110
7.7.1.2	Setting up the WiFi Interface on the D11 & D12 Controllers.....	111
7.7.2	PID & CC Status Icon	112
7.7.2.1	Improve Data Transfer Security via HTTPS	112
7.7.2.2	Password Reactivation	112
7.7.3	Bug Correction	112
7.7.3.1	Quick Navigation (Right/Left) User Interface Crash (R-UI).....	112
7.7.3.2	Special Characters In APN Settings.....	112
7.7.3.3	Inverted Solenoid Command in French Interface	113
7.7.3.4	Time Zone & Linux Epoch Wrong in AreaS without Daylight Saving.....	113
7.8	Since Release 2.5.0 (06.08.2019)	113
7.8.1	Zero Set Point Closure (Only D22)	113
7.8.1.1	Features Menu	113
7.8.2	PID Bumpless Transfer with Multi PID (Only D22)	114
7.8.3	Modify the Valvapps Name when Regulation is Modified.....	115
7.8.4	Delay Option In "Action" Menu.....	115
7.8.5	Extension of Control Curves Activation Base on a TIME Period CONDITION.....	116
7.8.6	"OPTICON": Solenoid Output Power Consumption Optimization (D22 Only).....	116
7.8.7	Import and/or Export Files via the Web Interface	116
7.8.8	Modbus New Data Model (New Table).....	117
7.8.8.1	Force Devices to Use TLS 1.2 and Certificates.....	117
7.8.9	Bug Correction	117
7.8.9.1	Log Export on USB Broken	118
7.8.9.2	R-UI Crash After Modem Busy Error	118
7.9	Since Release 2.6.0 (04.05.2020)	118



7.9.1	Possibility to Use CV-Log Alerts in Action (Only D22)	118
7.9.1.1	Log Files Are no Longer Deleted During an Engine Update	120
7.9.1.2	Backup Into SD and SD Stockage Improvement	120
7.10	Since Release 2.8.0 (30.03.2021)	120
7.10.1	Compatibility with e-Lift-35 on the D12	120
7.10.1.1	Custom APN for 4G Communications	121
7.10.1.2	WiFi Access Point - Limited Number of Characters	122
7.10.1.3	Special Character "@"	122
7.10.1.4	DPM EMEA	122
7.11	Since Release 2.8.2 (11.03.2022)	122
7.11.1	Set Logging Time Precisely on the D22 & D12	122
7.11.1.1	Fix for SD Card Read / Write Problems	123
7.11.1.2	Remote Control Curve Modification Refused when one CC is Off	123
7.12	Since Release 2.8.3 (01.10.2022)	123
7.12.1	Allow Update FW Telit ME910 Modem 4G for D22	123
7.12.2	Update Microchip (PIC18F86K22 vs. PIC18F87K22)	124
7.12.3	Improved Security	125
7.12.4	Remove "R-ACCESS" User Name from Test Report	125
7.12.5	Modbus TCP/IP Menu Clarification	125
7.12.6	Modbus Override Value	126
7.12.7	Bug Corrections	127
7.12.7.1	Infinite Retres Downloading Remote R-Engine Update	127
7.12.7.2	Custom Scaling Doesn't Show Decimal Value after Validation	127
7.12.7.3	ValveFlow Calculation with Decimal Value for D12	128
7.13	Since Release 2.8.4 (17.02.2023)	128
7.13.1	Allow Negative Flow Value	128
7.13.2	Libraries Update	128
7.13.3	Bug corrections	128
7.13.3.1	Multiple Control Curve Points at the Same Time	128
7.13.3.2	Reboot After Removing a Control Curve Point	128
7.13.3.3	Bad Formatting of .csv fileS BY d12/d22 with Engine 2.8.3	128
7.14	Since Release 2.8.5 (17.08.2023)	129
7.14.1	Main Improvements	129
7.14.1.1	ValveFlow Improvements (Before DP Metering)	129
7.14.1.1.1	Valve	129
7.14.1.1.2	Manage Table	129
7.14.1.1.3	Output	130
7.14.1.2	Load Standard ValvApps without Factory Reset	130
7.14.1.3	Add Totalizer via the Configuration Menu	131
7.14.1.4	Add New Outputs on the Fly	131
7.14.2	Bug Corrections	132
7.14.2.1	Prevent Register if e-Mail Field is Invalid	132
7.14.2.2	GSM Signal Strength Measures Stuck at 0 (D12 only)	132



7.14.2.3	Control Curves Round Output to Whole Number when Using 2 Decimals	132
7.14.2.4	Fix for Slow Network FTP Communication	132
7.15	Since Release 2.8.6 (25.04.24)	133
7.15.1	New Features	133
7.15.1.1	Modbus Log-to-Disc	133
7.15.1.2	R-loader Access from Advanced Settings Menu	134
7.15.2	improvements	134
7.15.2.1	Cellular Network	134
7.15.2.1.1	Icon Name	134
7.15.2.1.2	Network	134
7.15.2.1.3	Setup	135
7.15.2.2	E-Drive Menu	135
7.15.2.3	Options for Handling Signal Losses on DI_F	136
7.15.3	Bug Fixes	136

1 INTRODUCTION

1.1 PRECAUTIONS BEFORE STARTING



Before usage, make sure that the latest software version is installed on your device. You can download the latest software from: www.cla-val.ch.



This equipment must be handled with precaution. CLA-VAL electronic products are robust and designed to work under field environmental conditions, but high shocks and strong mechanical constraints can damage the equipment and/or alter its functionality.

1.2 TROUBLESHOOTING

1.2.1 NOTHING ON THE DISPLAY

1. Check if there is a proper power supply applied to the electronic valve controller. A clean 12 VDC to 24 VDC continuous voltage must be provided to one of the "V+" connections in the junction terminal (grounded to the "V-").
2. Check that the screen is not in standby mode by clicking on one of the five navigation buttons. If the screen switches on, you can unlock the screen by clicking two seconds on the "Home/Ok" button.

1.2.2 AN INPUT OR VARIABLE IS DISPLAYED IN RED, ORANGE OR BLUE

See the colour coding convention used on the electronic valve controller for the inputs, outputs and variables in chapter 3.1.

1.2.3 ISSUE WITH THE BEHAVIOUR OF THE VALVAPPS™

Refer to the technical datasheet related to your **ValvApps™**, and especially the block diagram and the logic scheme explaining its behaviour.

For any remaining issue, please contact CLA-VAL.

1.3 GENERAL DISCLAIMER

In accordance with our policy of continuous development and improvement, CLA-VAL reserves the right to modify or improve its products at any time without prior notice. CLA-VAL assumes no liability or responsibility for any errors or omissions in the content of this document.

1.4 ENVIRONMENTAL PROTECTION

Help to preserve and protect the environment. Recycle used equipment and accessories.

1.5 TYPOGRAPHY

Throughout this manual, the following typographical conventions and symbols have been adopted to help readability:

- a. **"Bold"**: Menu, command, tab and button.
- b. ***BOLD ITALIC***: Important information.
- c. **(1)**: Number of the reference marks on image.
- d. www.cla-val.ch: Web-site address.



- e.  : Some tips.

- f.  : Warning!

2 ELECTRICAL & MECHANICAL DETAILS

2.1 TECHNICAL CHARACTERISTICS

Enclosure	
Material	Flame retardant PC/ABS plastic
Connections	M16/M20 IP-68 Cable Glands IP-68 USB Type A IP-68 RJ45 Ethernet Port
Dimensions	227 mm (8.94") H x 160 mm (6.3") W x 95 mm (3.74") D
Protection	IP68 (1 month under 2 meters)
Mounting Bracket	Stainless steel
Power Requirements	
Voltage Input	12 VDC to 24 VDC
Power Consumption	1.9 W in stand-by, 3 W nominal when regulating (up to 30 W peak consumptions)
Protection	32 VDC over-voltage protection Reverse voltage protection
Inputs (Screw Connection I/O terminal)	
Analog (AI1 to AI6)	6 (six) 4-20 mA inputs (max. voltage = 32 VDC)
Digital (DI1 to DI6)	6 (six) dry contacts inputs (max. voltage = 5 VDC @ 0.1 A, max. frequency = 100 Hz)
Units	Configurable
Decimal point	1 ("0") to 4 ("0.000") significant digits
Signal filter	Cumulative filter configurable 1% to 99%, or disabled
Totalizer	Configurable input and units
Outputs (Screw Connection I/O terminal)	
Analog (AO1 to AO4)	4 (four) 4-20 mA outputs (10-bit resolution, impedance = 500 Ω)
Solenoid (SO1 and SO2)	2 (two) solid state relay (24 VDC @ 0.5 A - binary or proportional)
Relay (RO1 and RO2)	2 (two) mechanical relay (max. voltage 24 VDC or 240 VAC, max. current 2 A)
PID Control Parameters	
Proportional Band	0% to 100% (adjustable in 1% increments - independently for opening and closing)
Dead Band	Adjustable from 0 to full-scale of set-point signal
Cycle Time	0 s to 60 s (adjustable in increments of 1 s)
Integral Band	0 s to 60 s (adjustable in increments of 1 s)
Derivative Band	0 s to 60 s (adjustable in increments of 1 s)
Loop Zoning	Up to 4 zones
PID Loops	Up to 4
Display & Navigation	
Display	4.3" color display (272 x 480, 24-bit)
Navigation	5 (five) mechanical push buttons
Communication	
Interfaces	Ethernet, 2G / 3G / 4G (GPRS, LTE-M, NB-IoT), RS-232 & RS-485, USB
Protocols	Modbus RTU, Modbus TCP, VNC, FTP
Logging	
Process	Manual and Automatic
Memory	Internal memory, SD card (4 GB default), Export to USB, Export to FTP server
Logging speed	1 minute
Format	CSV file (proprietary format)
Temperature Range	
Working Temperature	-10°C to +80°C
Storage Temperature	-30°C to +85°C

2.2 MECHANICAL DETAILS

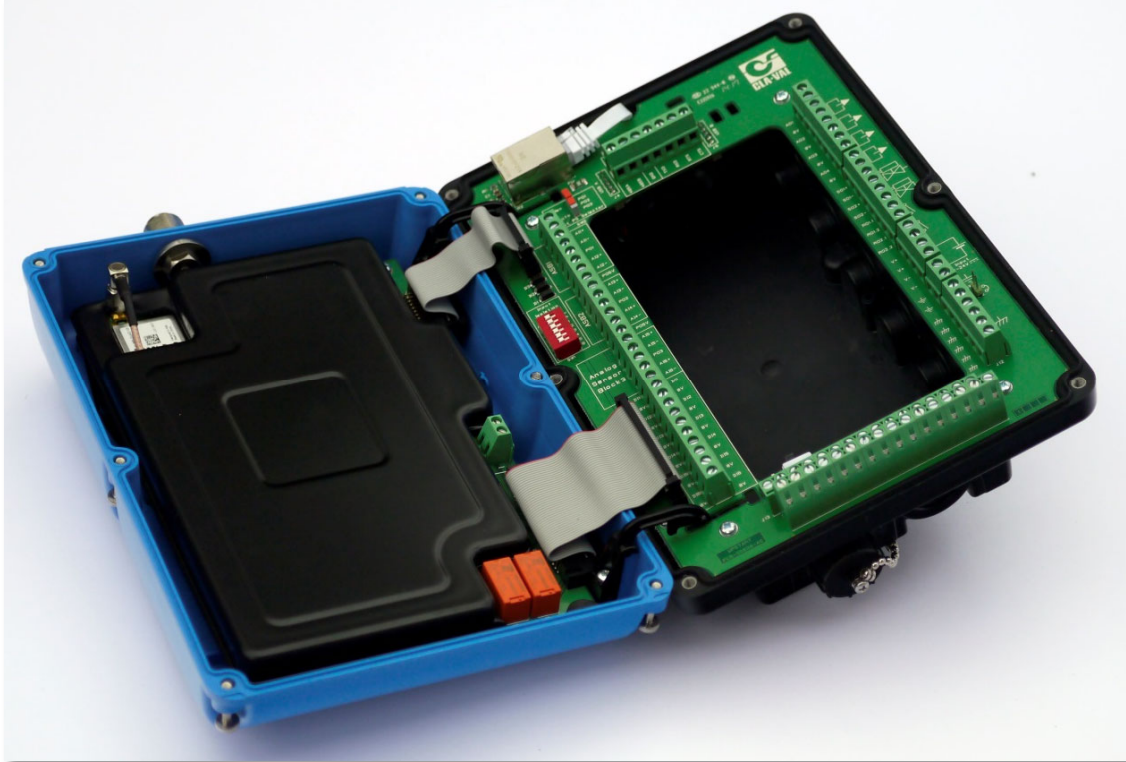

The product is composed of two separable sub-parts:

- **Cover:** this part contains the main electronic board implementing all the control electronics of the electronic valve controller.
- **Junction board:** this part contains the connection blocks for the power supply, inputs and outputs.

2.2.1 JUNCTION BOARD INTERNAL CONNECTIONS

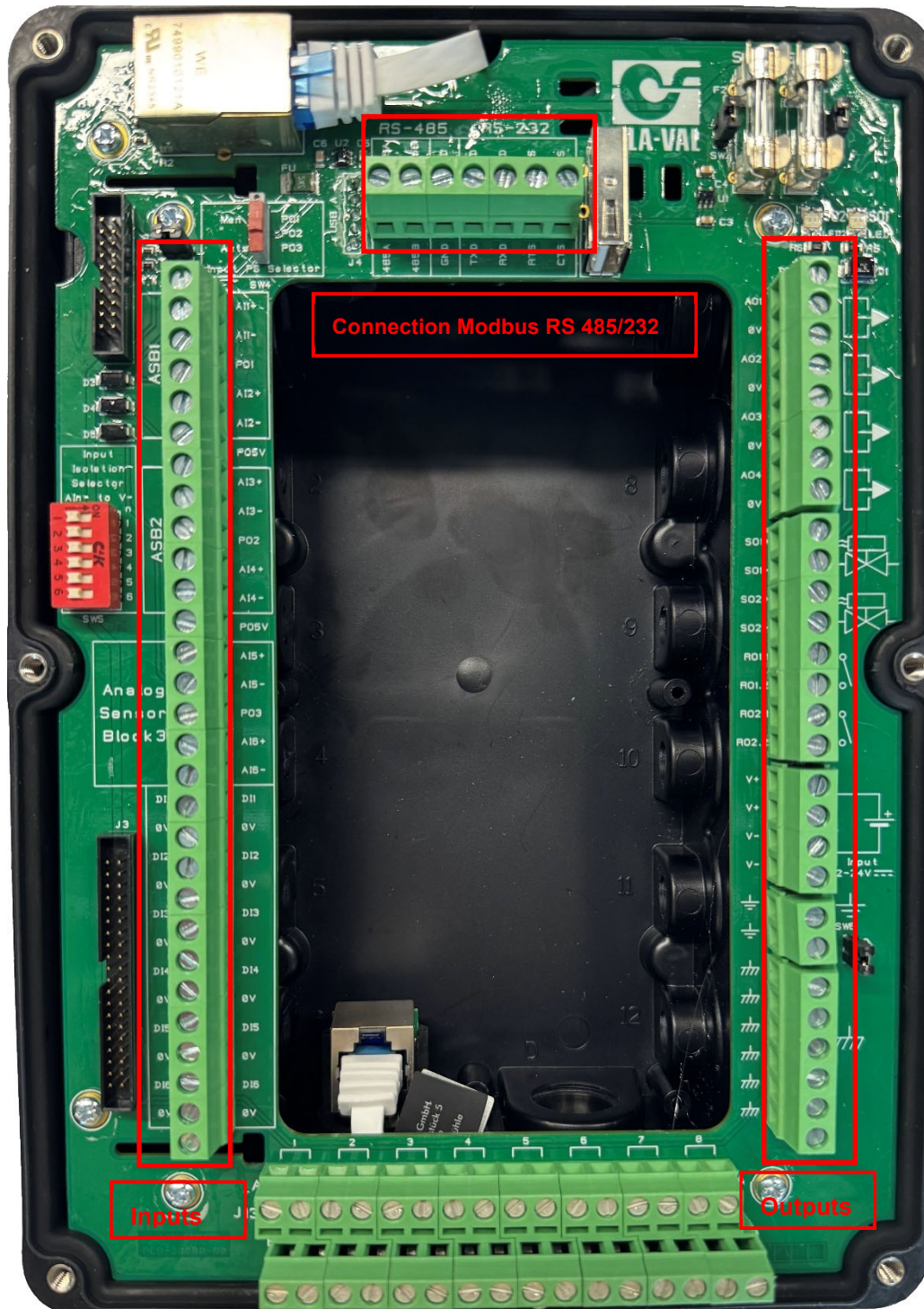

2.2.2 JUNCTION BOX CABLE GLANDS / SIZES / LOCATIONS

To ensure IP68 protection, the junction box is interfaced via cable glands (optionally Souriau™ connectors).

A) Multi-Conductor Cable Size / Wire Gauge. **Note:** To preserve IP68, the following must be respected.

- M12 Multi-Conductor Cable Size Range: 3 mm - 6 mm (0.12" - 0.26").
- M16 Multi-Conductor Cable Size Range: 5 mm - 10 mm (0.20" - 0.39").
- M20 Multi-Conductor Cable Size Range: 6 mm - 12 mm (0.24" - 0.47").

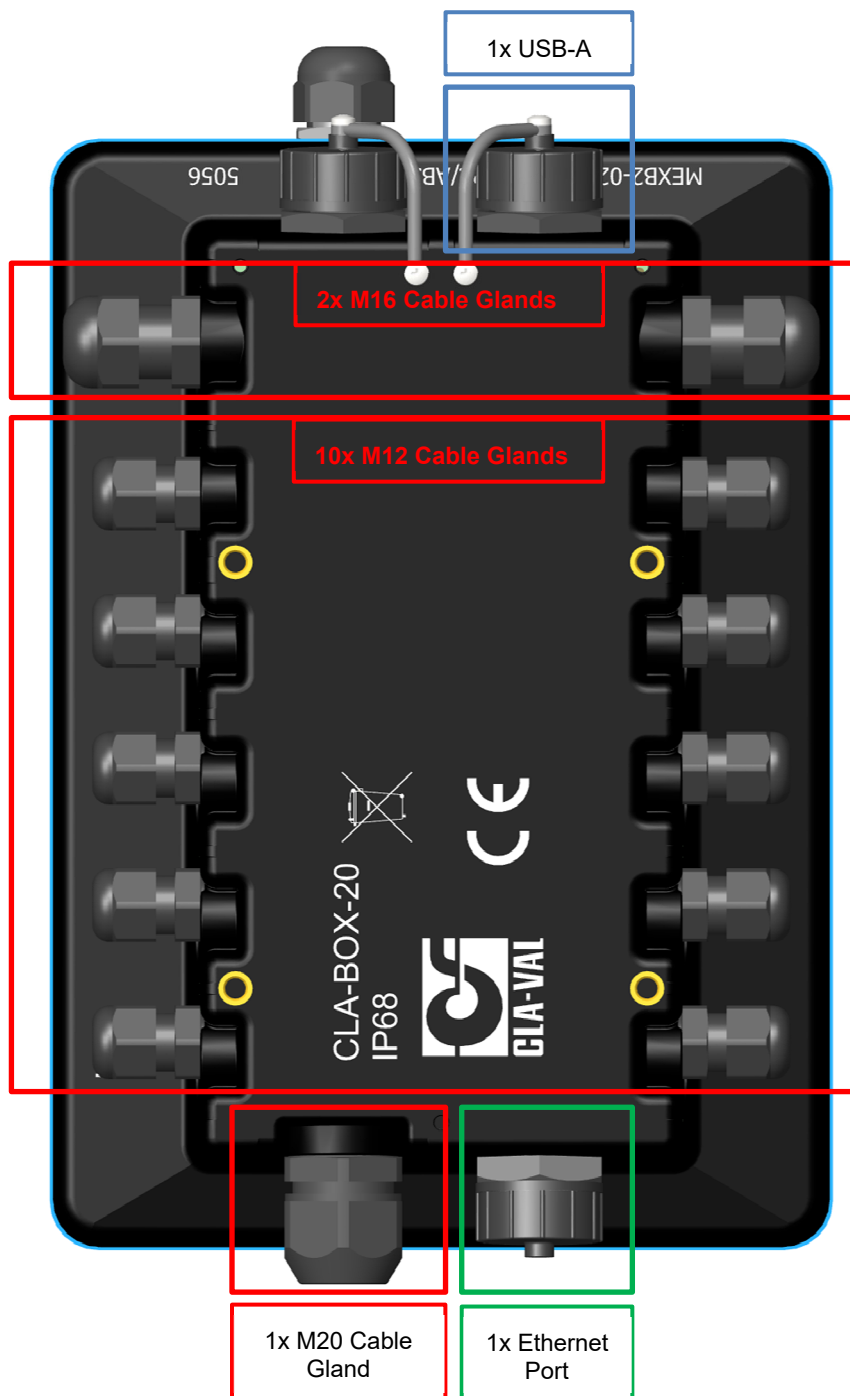

B) Ethernet

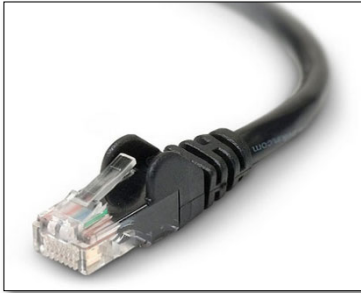

In the Ethernet port, it is possible to connect RJ-45 Ethernet cables, just like those shown in the photo on the left side.

C) USB-A



The USB-A slot gives the possibility to connect standard USB Flash Drives (shown in the photo on the right side).

2.2.3 COVER PART

The cover part is physically separable from the junction board. This part of the product contains all the control electronics of the electronic valve controller. The cover should not be opened and is not intended to be accessed by the user, except for memory or SIM card access.



2.3 PHYSICAL MOUNTING

2.3.1 OVERALL DIMENSIONS

For all drawings below, units are in millimeters (inches).

- Control box.

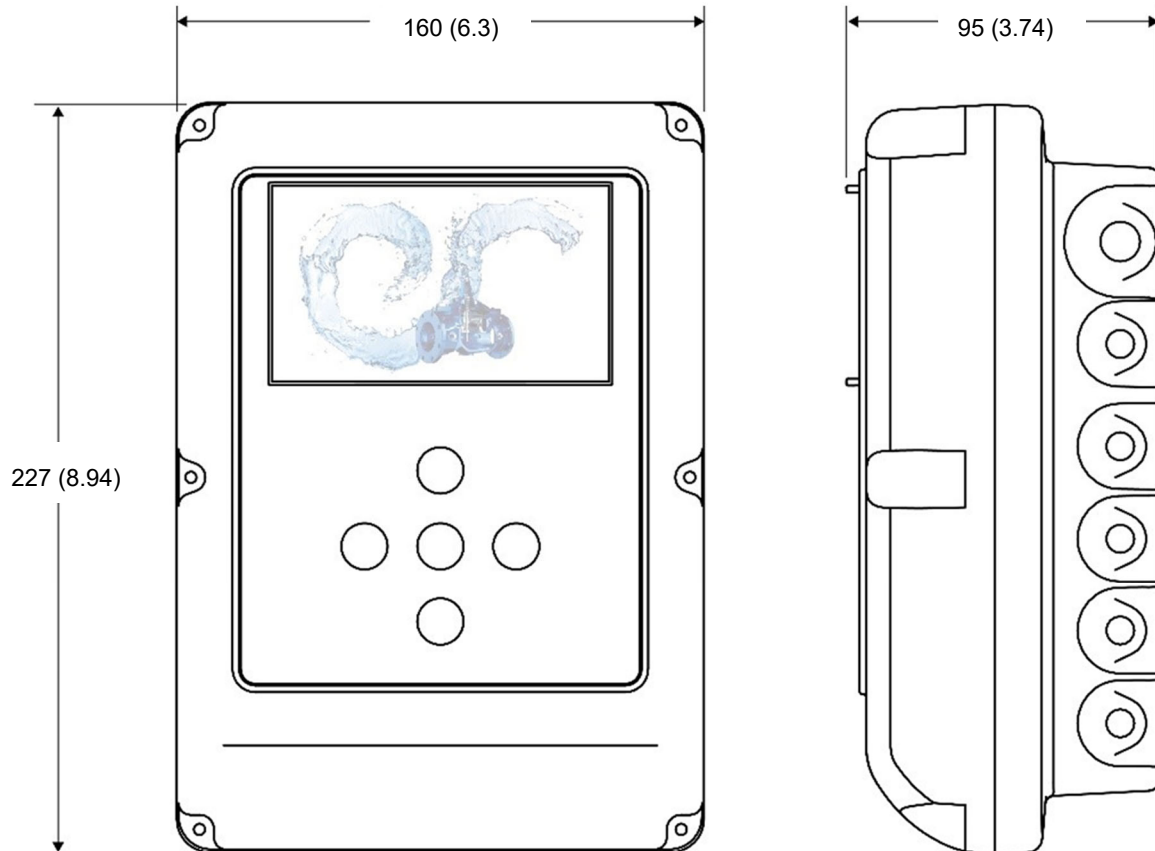

- With antenna and wall-mounting bracket.

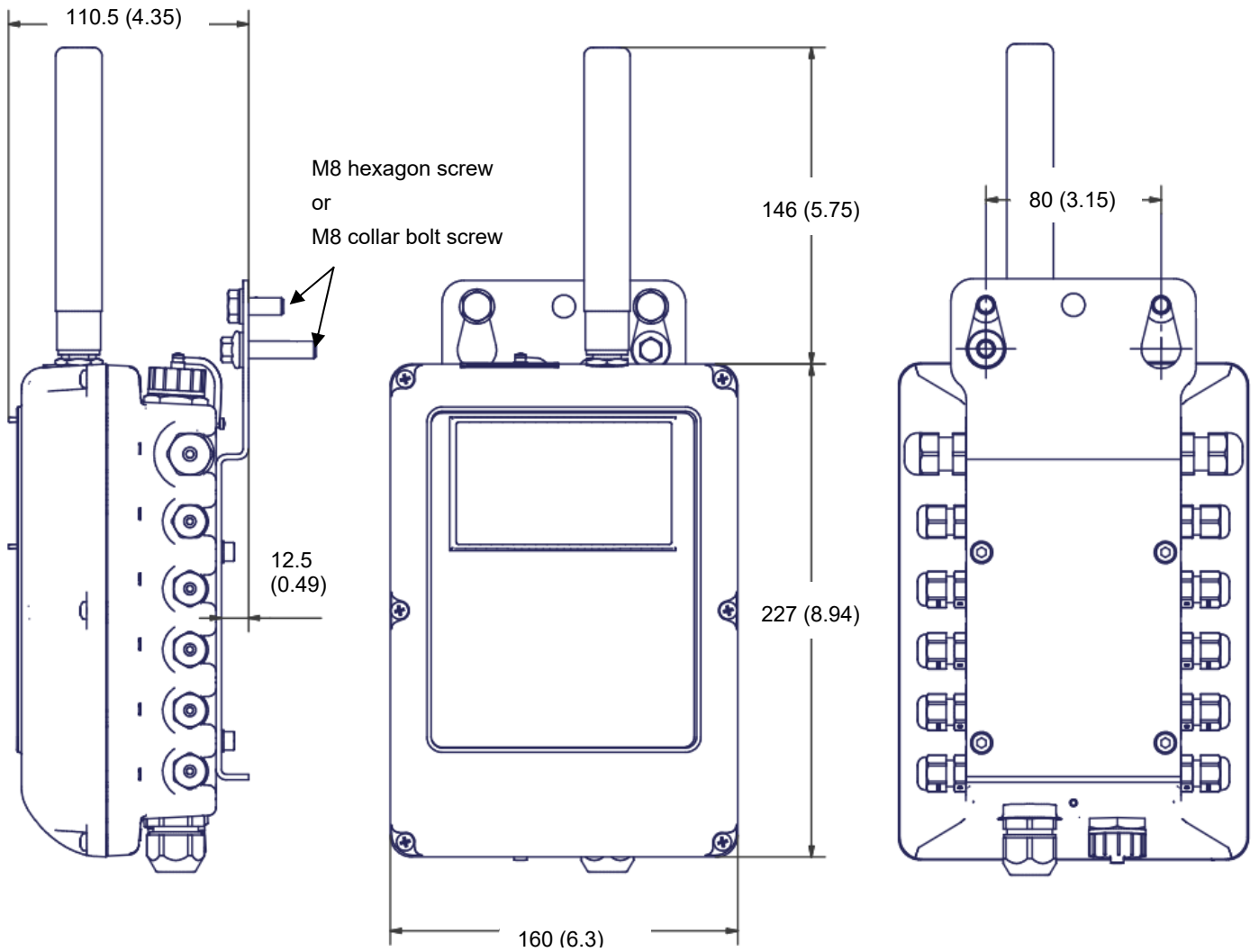

- Cla-Box 10 (accessory box - U1 option).

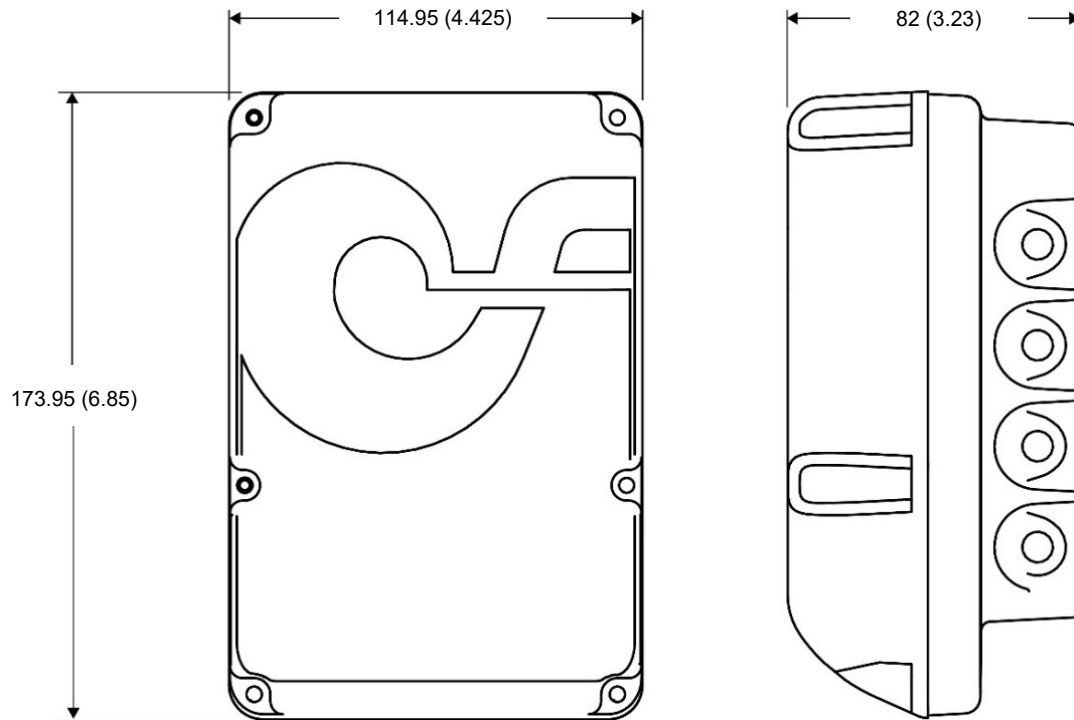

2.3.2 BOLT PATTERN

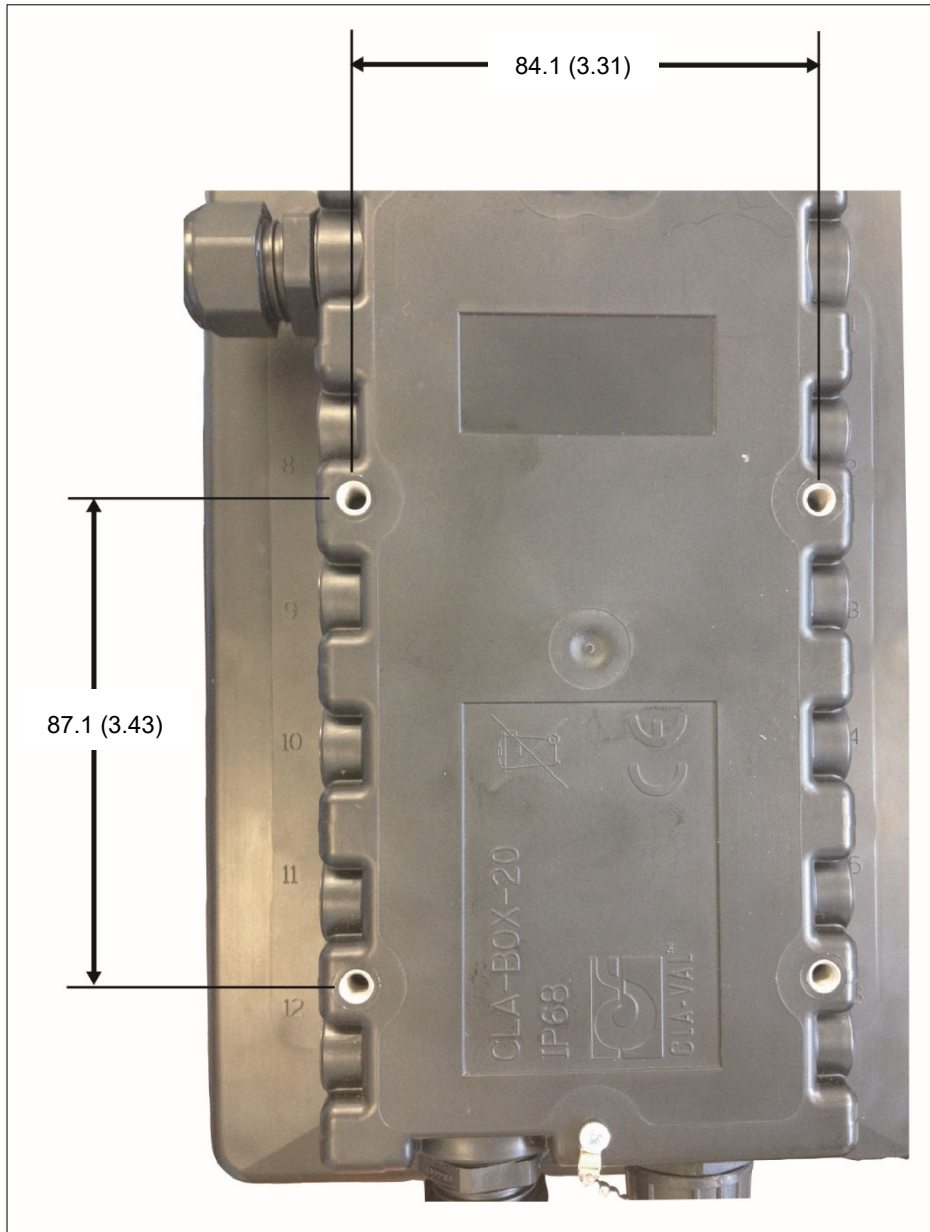

2.4 HARDWARE INPUTS/OUTPUTS (I/O)

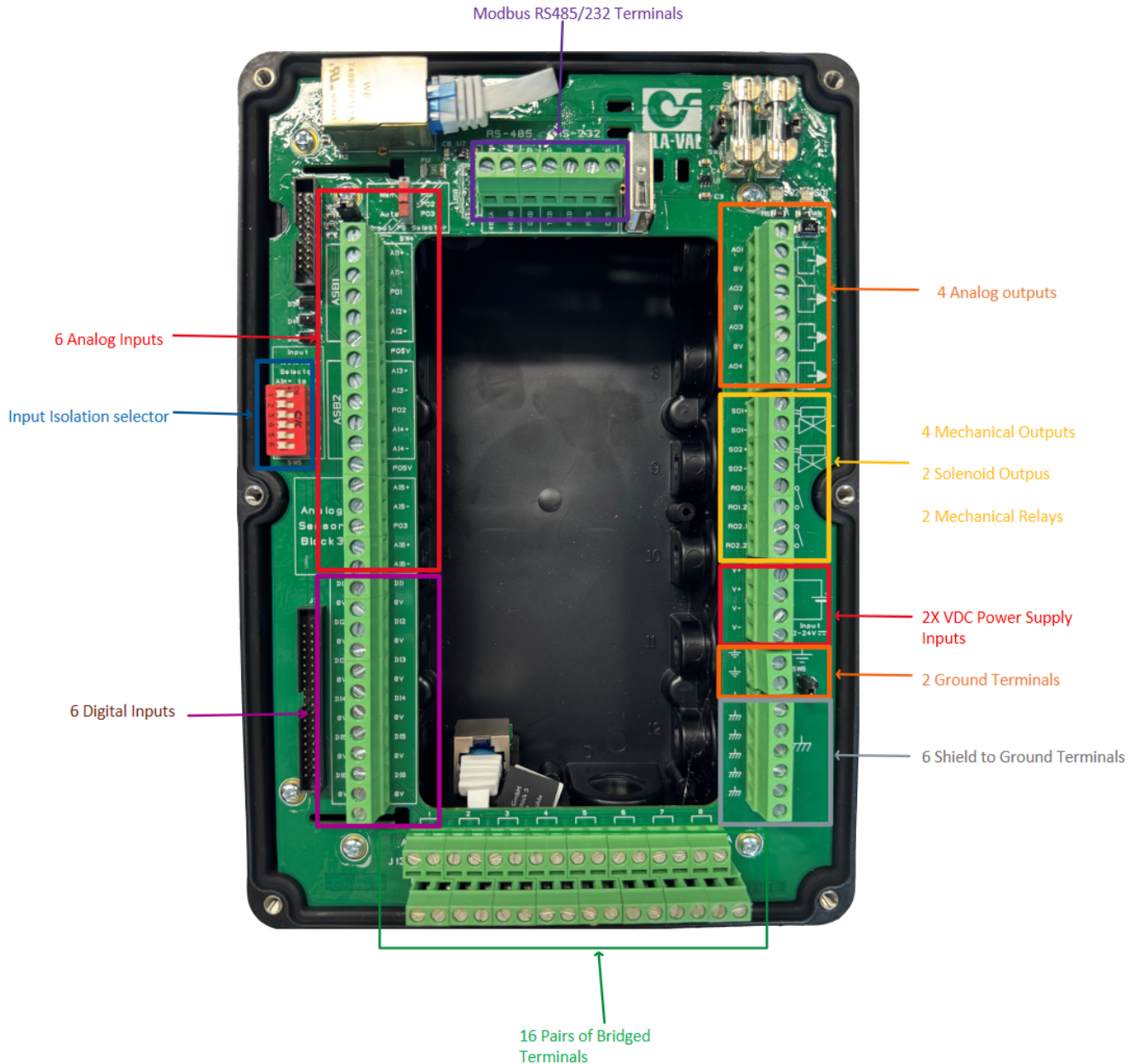

- Inputs:
 - Six Analog Inputs (AI).
 - Six Digital Inputs (DI).
- Outputs:
 - Four Analog Outputs (AO).
 - Four Mechanical Outputs: 2x Solenoid Outputs, 2x Contact Closures (mechanical relays).

2.5 WIRING ANALOG INPUTS FOR 4-20 MA SENSORS

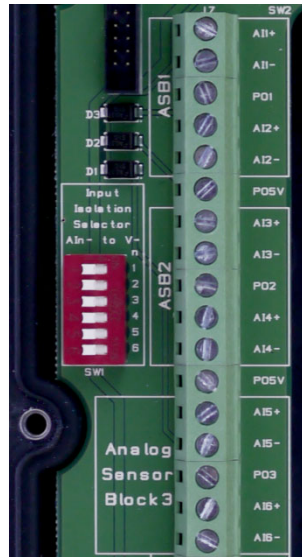

2.5.1 2-WIRE 4-20 MA SENSOR (LOOP POWER)

2.5.1.1 2-wire (Externally Powered)

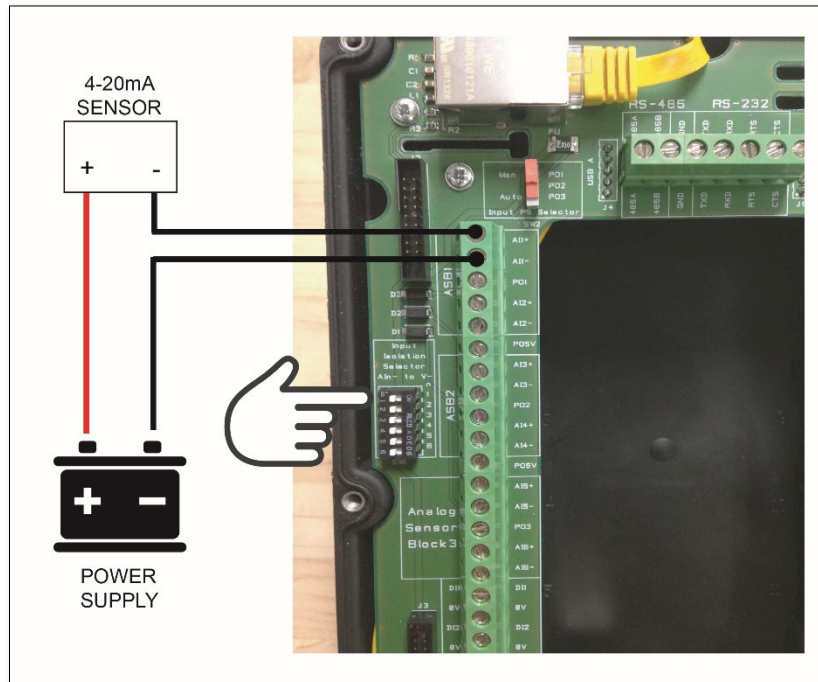

For isolated 2-wire signals, the power supply, sensor and electronic valve controller make a continuous loop, allowing the current to be measured by the electronic valve controller.

 For isolated signals, ensure that the "Isolation Selector Switch" is set to the **LEFT** or "OFF".

Examples: Mag Meter

2.5.1.2 2-wire (Internally Powered)

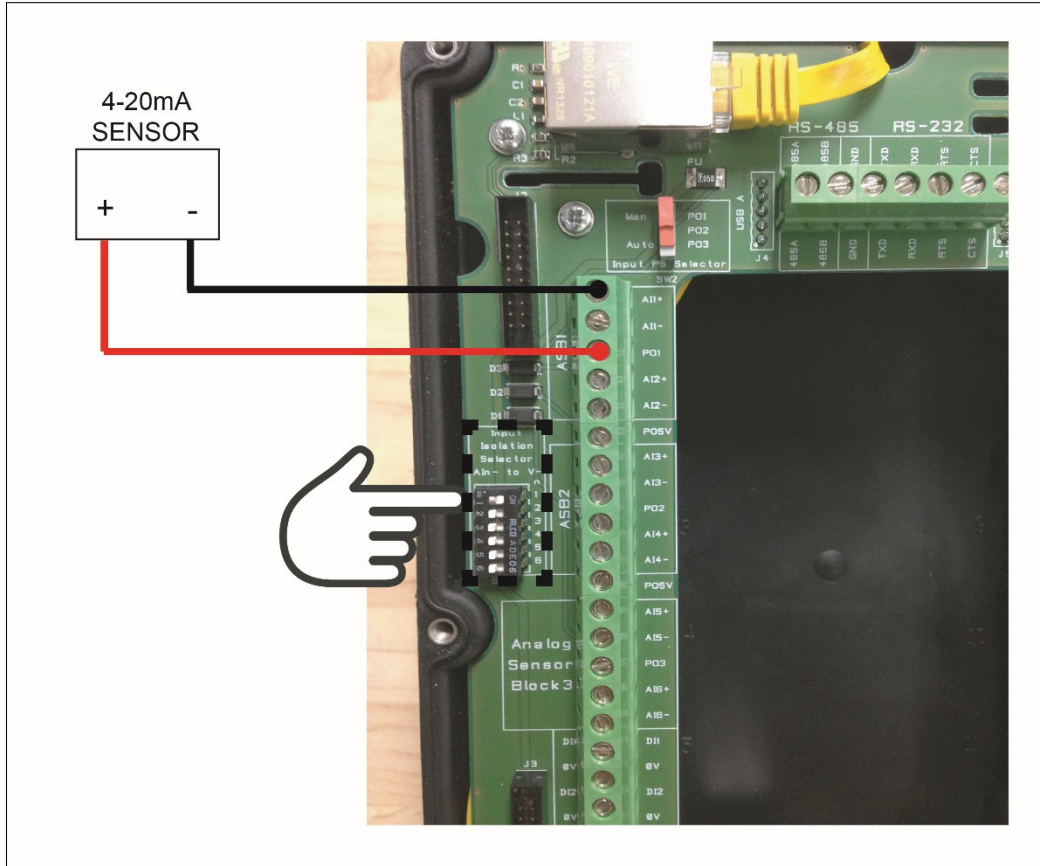

For non-isolated signals, the electronic valve controller provides the power for the sensor and makes a continuous loop, allowing the current to energize the sensor and then be measured by the electronic valve controller.

 For non-isolated signals, ensure that the "Isolation Selector Switch" is set to the **RIGHT** or "**ON**".

Examples: e-FlowMeter, pressure transducer.

2.5.2 4-WIRE 4-20 mA SENSOR

2.5.2.1 4-wire (Externally Powered)

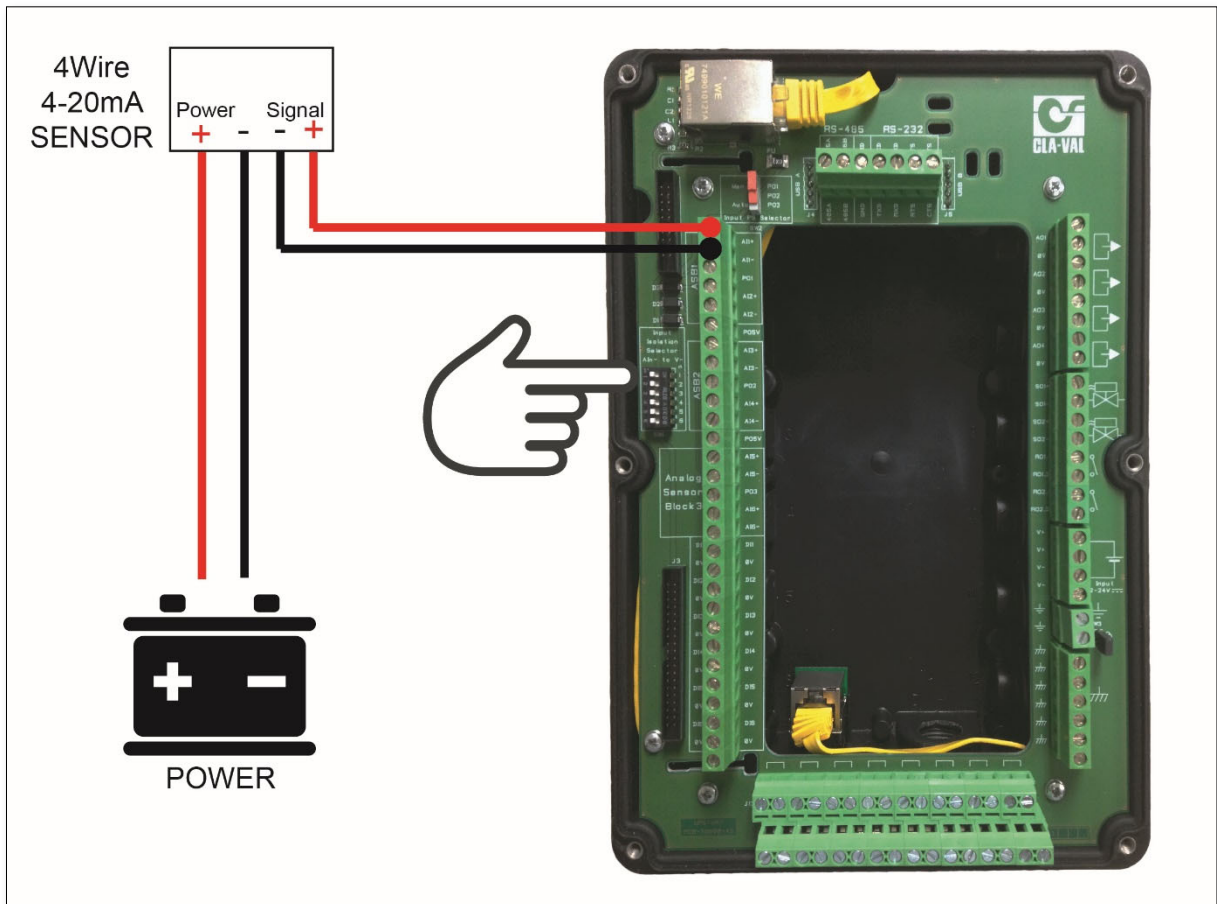

For 4-wire signals, the sensor is externally powered usually using 2 wires. The two signal wires coming from the sensor are then measured by the electronic valve controller in the analog input section of the terminal board.

 For 4-wire signals, ensure that the "Isolation Selector Switch" is set to the **LEFT** or "**OFF**".

2.5.2.2 4-wire (Internally Powered)

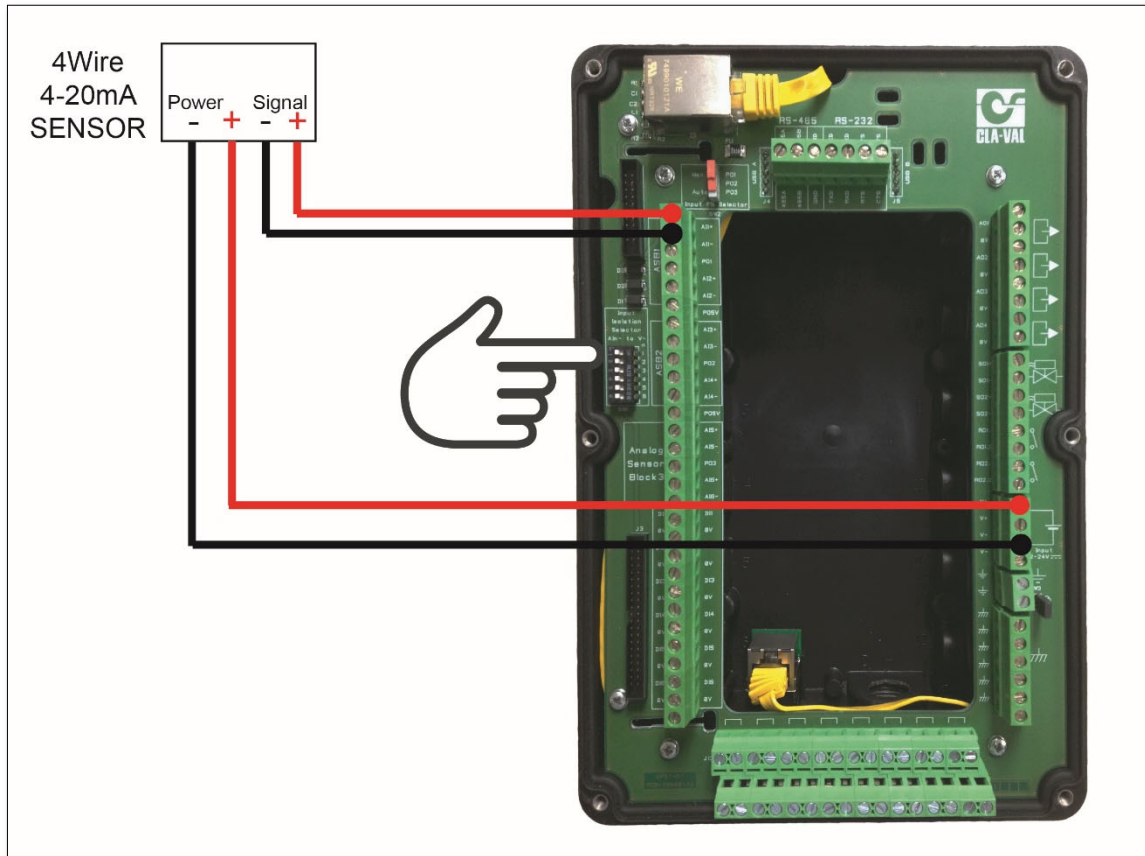

For 4-wire internally powered signals, the sensor is powered directly from the main electronic valve controller power supply terminals. The two signal wires coming from the sensor are then measured by the electronic valve controller in the analog input section of the terminal board.

 For isolated signals, ensure that the "Isolation Selector Switch" is set to the **LEFT** or "OFF".

2.6 WIRING DIGITAL INPUTS



2.6.1 MECHANICAL RELAY

A mechanical relay can be used as a digital input because the state is either open (1) or closed (0). Depending on how the input is configured, action can be taken when this mechanical switch closes or opens.

Typical application: position/limit/proximity/level switch.

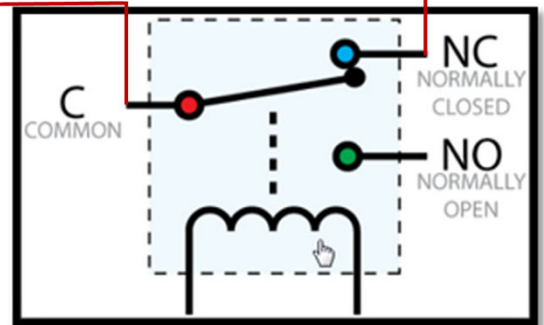

2.6.2 NPN TRANSISTOR

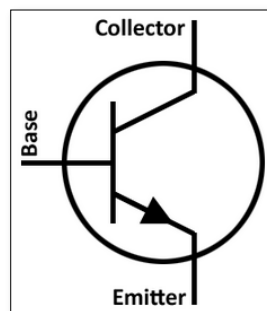

An NPN transistor can be used as a digital input because the state is either open (V+) or closed (V-). Depending on how the input is configured, action can be taken when this NPN transistor switches state.

Typical applications: digital pulse output from flow meter or register counter.

2.7 OUTPUTS SOLENOIDS

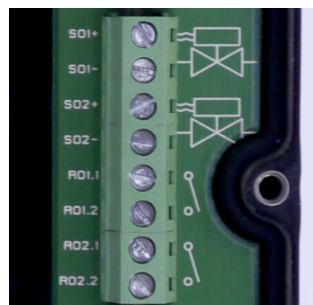

2.8 POWER SUPPLY

2.8.1 DC INPUT POWER

The electronic valve controller requires a continuous voltage of 12-24 VDC. The electronic valve controller consumes typically 0.9 W in standby mode and 3 W in usage; its peak power consumption can go up to 30 W.

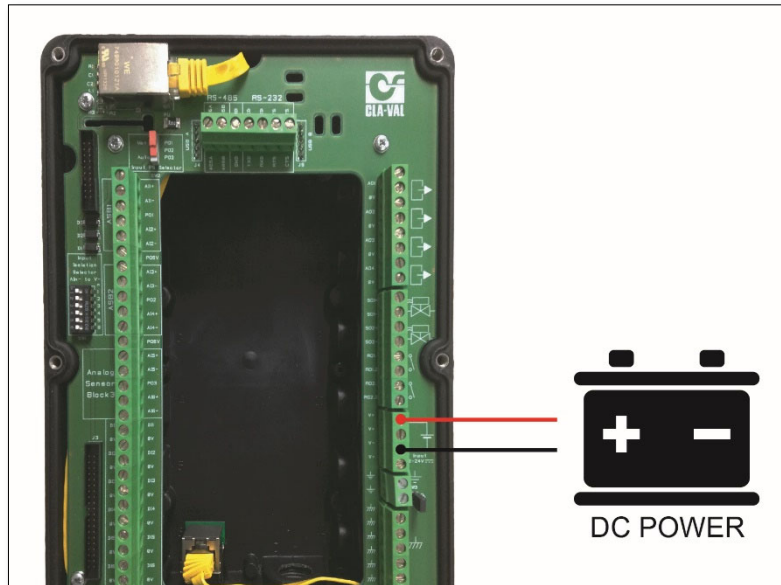

2.8.2 AUTONOMOUS POWER SUPPLY

The **CLA-VAL e-Power IP** power supply is the ideal compact power generator for the electronic valve controller to get a completely autonomous valve.

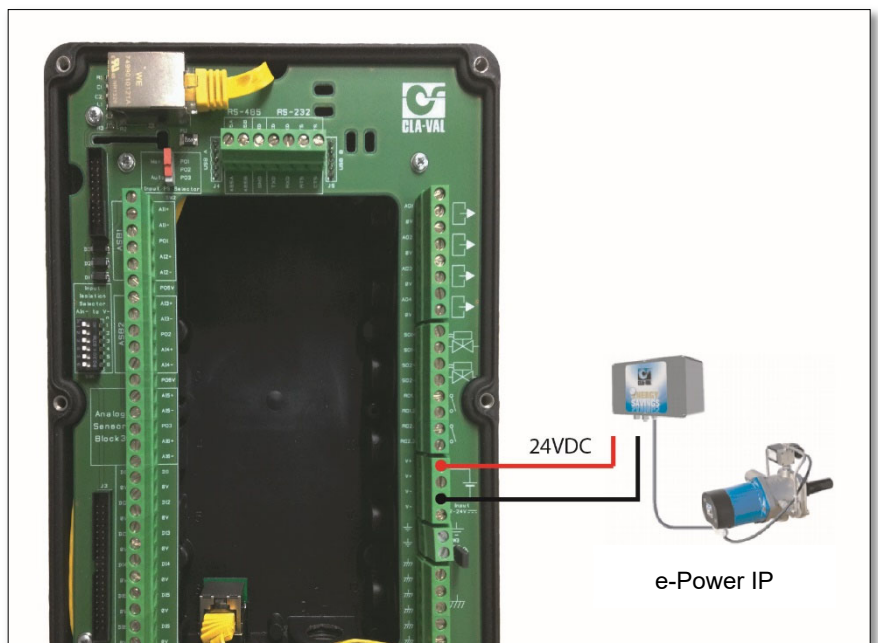
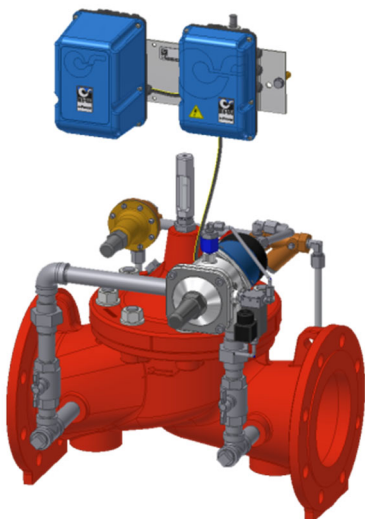

2.8.3 ALTERNATIVE POWER SUPPLIES

2.8.3.1 Solar Panel

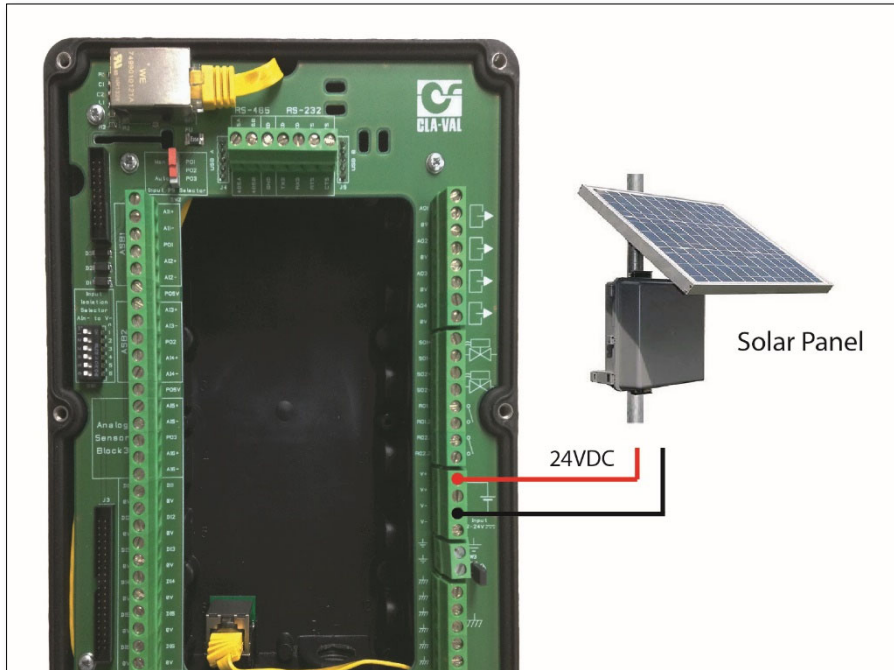

2.9 WIRING TROUBLESHOOTING

Check the wiring connections first. The large majority of electronics problems arise from mistakes in the wiring.

Use the continuity function of the meter to check and make sure that A connects to B.

If mistakes are made during the wiring, for example AI2 was wired in place of AI1, their positions can be rearranged by using the Input configuration menus instead of re-wiring all of the inputs.

3 NAVIGATION





3.1 COLOR CONVENTION

Values are usually displayed in black; however, input values can sometimes be displayed in different colours, depending on the status of the associated input:



- **Black:** normal status. The value displayed is what is measured on the input.
- **Red:** loss of signal. The associated input has no signal arriving.
- **Orange:** loss of signal, the system overrides the value.
- **Blue:** local override. The value has been manually overridden locally and the signal at the input is not taken into account.
- **Grey:** remote signal.

3.2 BASIC BUTTON FUNCTIONALITY







3.2.1 BUTTON DESCRIPTIONS

-  - Home/Ok.
-  - Left/Inp.
-  - Right/Output.
-  - Up/Valve configuration.
-  - Down/Settings.

Other icons in this manual:

-  - Short click (less than 1 second).
-  - Long click (more than 1 second).

3.2.2 SHORT CLICK - LESS THAN 1 SECONDS

-  Is "Ok" or "Select" when used as a  (short click).
-  - When used as a , the cursor moves to the left.
-  - When used as a , the cursor moves to the right.



- When used as a , the cursor moves up.

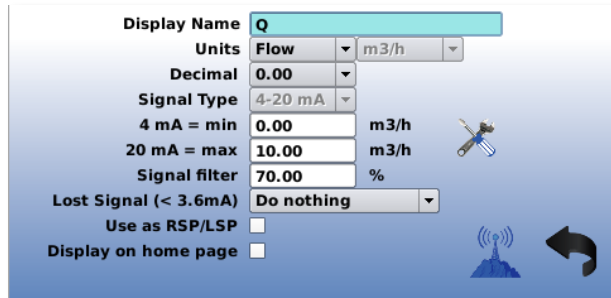

- When used as a , the cursor moves down.

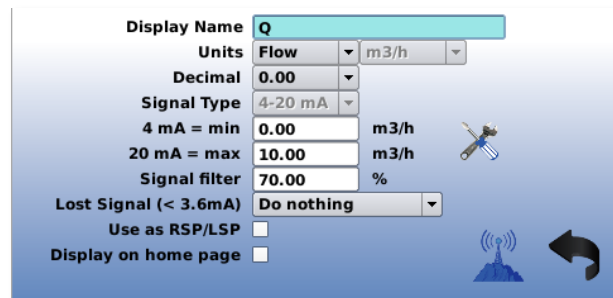

3.2.3 EXTENDED CLICK - MORE THAN 3 SECONDS ("HOME/OK" BUTTON ONLY)

From the home screen, on "Home/Ok" will put the electronic valve controller into sleep mode.



From any other location, a  on the **"Home/Ok"** button returns to the home screen.

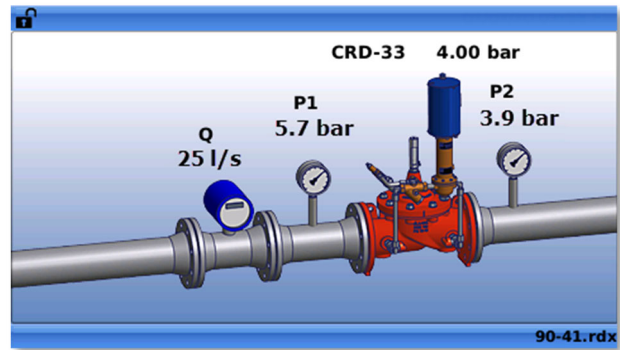



3.3 INFORMATION SCREENS

The information screens appear after a  on one of the side buttons.

3.3.1 SCREENS DESCRIPTION

3.3.1.1 "Schematics"

1. **"Short Click"**: View Valve Information (from home screen).

From the home screen, a  on the  button navigates to the **"Valve Information"** screen.

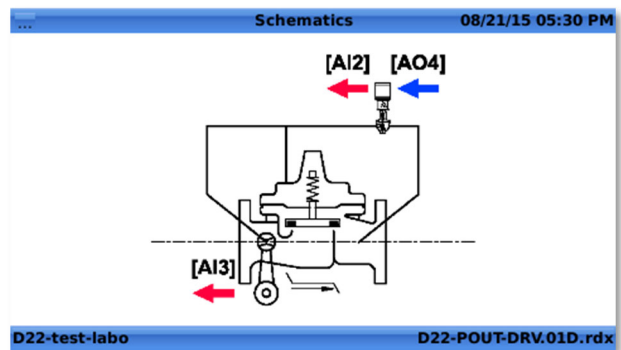

3.3.1.2 "Inputs"

1. "Short Click": View Input Information (from home screen).

From the home screen, a  on the  navigates to the "Inputs" screen.



Inputs		08/21/15 05:28 PM
[AI2]	CRD FB	4.0 bar
[AI3]	Q FB 4-20 mA	50.2 l/s
[DI3_F]	Q FB Pulses	0.00 l/s

D22-test-labo D22-POUT-DRV.01D.rdx

3.3.1.3 "Output"

1. "Short Click": View Output Information (from home screen).

From the home screen, a  on the  navigates to the "Outputs" screen.



Sorties		22/07/22 10:45
[SO1]	Closing Sol	0.0 % /5s
[SO2]	Opening Sol	0.0 % /5s
[RO1]	PowerSupplyManag0	

3.3.1.4 "Display Panel"

1. "Short Click": View variables Information (from home screen).

From the home screen, a  on the  navigates to the "Variable" screen.



Panel		18/06/24 13:44
[VAR]	CP Target	500
[VAR]	Cycle Time	10 s
[VAR]	DB	100
[VAR]	dP	0.5 bar

3.4 CONFIGURATION TABS

The configuration screens appear after an on the side buttons.

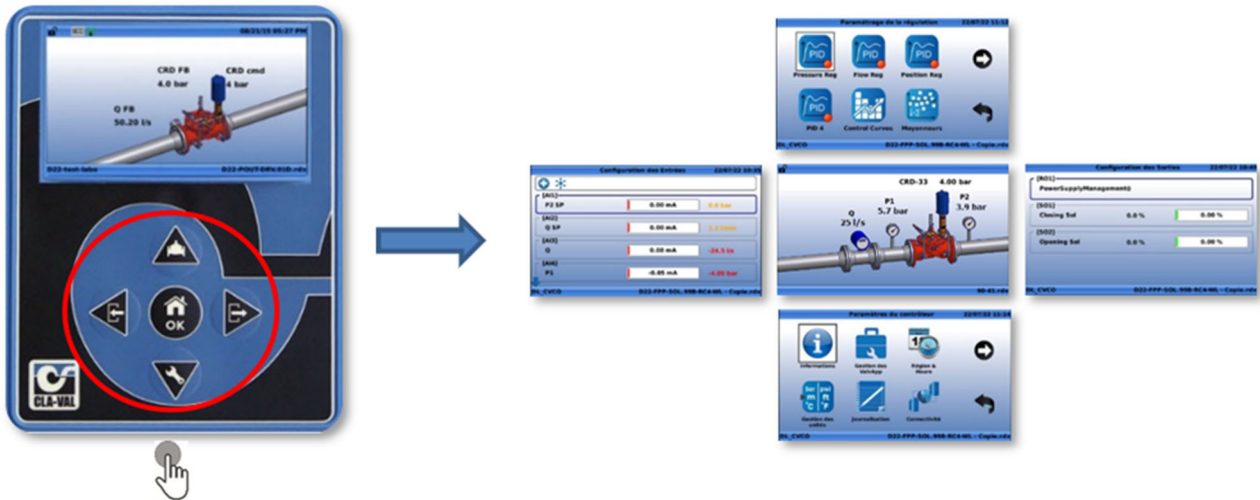

3.4.1 "CONFIGURE INPUTS" MENU

1. "long click" on
2. Select the input.
3. "short click" on

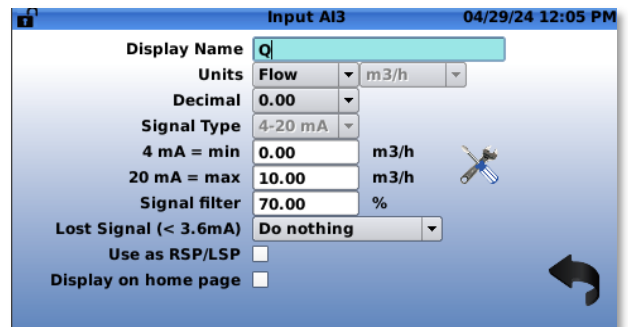
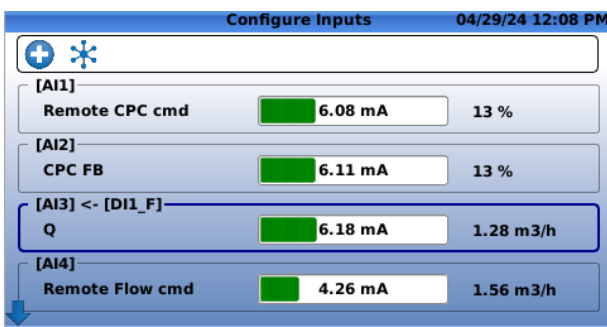



Analog Input Field Descriptions:

- "Display Name": Use this field to choose a unique name for each input.
- "Units": Choose from the available units of:
 - (gpm) - Gallon per minute [flow].
 - (mgd) - Mega Gallons per day [flow].
 - (cfm) - Cubic Feet per minute [flow].
 - (cfs) - Cubic feet per second [flow].
 - (l/min) - Liter per minute [flow].
 - (l/s) - Liter per second [flow].
 - (m3/h) - Cubic meters per hour [flow].
 - (Ml/d) - Mega liters per day [flow].

- (Imp gpm) - Imperial Gallons per minute [flow].
- (bar) - Bar [pressure].
- (kPa) - Kilopascals [pressure].
- (Mhd) - Mega Hectares per day [flow].
- (psi) - Pounds per square inch [pressure].
- (m) - Meters of water [pressure].
- (in) - Inches of water [pressure].
- (ft) - Feet of water [pressure].
- (%) - Percentage [unit-less].
- (h) - Hours [time].
- (min) - Minutes [time].
- (s) - Seconds [time].
- (gal) - Gallons [volume].
- (mg) - Mega gallons [volume].
- (cf) - Cubic feet [volume].
- (l) - Liters [volume].
- (m³) - Cubic meters [volume].
- (Ml) - Mega liters [volume].
- (mA) - Milliamps [electrical flow].
- (Volt) - Volts [electrical potential].
- **"Decimal"**: Select from available decimal places:
 - 0
 - 0.0
 - 0.00
- **"Signal Type"**: Select from available signal types:
 - 4-20 mA.
- **"4mA = min"**: Set the value of the input at 4 mA; usually this will correspond to a value of 0.
- **"20mA = max"**: Set the value of the input at 20 mA; this should correspond to the maximum measured value.
- **"Signal Filter"**: Select a filter length between 1% and 99%. This is a cumulative filter, where the value corresponds to the weight of the previous sample. The higher the value, the higher the filtering effect. A 0% value will inactivate the filter.
- **"Lost Signal (< 3.6 mA)"**: This menu designates which action the controller will take in the event that a signal falls below 3.6 mA, usually when there is a power outage or when the 4-20 mA loop has been broken.
 - **"Default Value"**: This option allows the user to input a value to be inserted when the 4-20mA input signal has been lost.
 - **"Keep Value"**: This option allows the user to specify that the last input value received by the controller will be the value that is used once the signal is lost.
 - **"Do nothing"** This option will specify that no action is taken by the controller when an input signal is lost.
- **"Use as RSP/LSP"**: When this box is checked, the input is treated as an RSP/LSP - Remote Set Point / Local Set
- **"Display on home page"**: While the box is checked this input is displayed on the home screen.

3.4.2 "CONFIGURE OUTPUTS" MENU

1. "long click" on 
2. Select the input.
3. "short click" on 

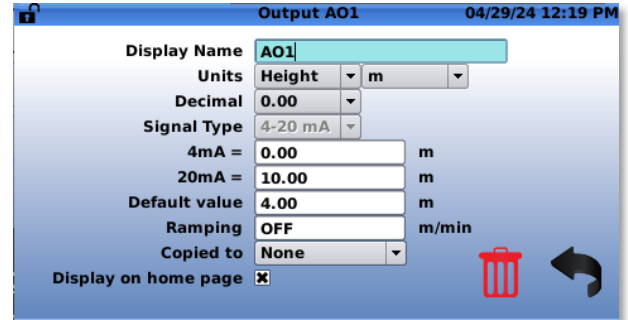
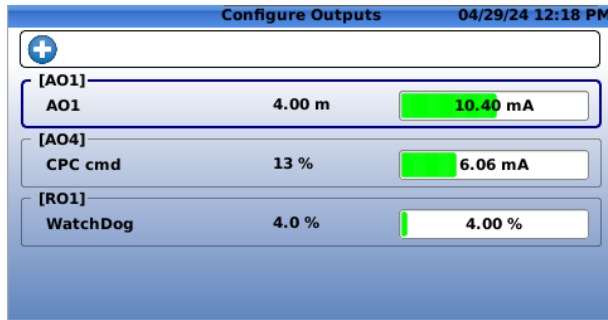

Solenoid Output Field Descriptions:

- **"Display Name"**: Use this field to choose a unique name for each output.
- **"Type"**:
 - **"PWM"**: (Pulse Width Modulation): this is the industry trade name for the management of pulses sent to the opening/closing solenoids.
 - **"Digital 1/0"**: Specifies that the output is either open or closed for the time specified in the boxes below.
 - **"Dry contact (1/0)"**: Impulsion while there is a state change.
- **"Cycle Time"**: The amount of time for one complete cycle of action for the opening/closing solenoid.
- **"Default Value"**: The default active time of the solenoid during the cycle.
- **"Display on home page"**: While the box is checked this input is displayed on the home screen.

Analog Output Field Descriptions:

- **"Display Name"**: Use this field to choose a unique name for each input.
- **"Units"**: Choose from the available units of:
 - (gpm) - Gallon per minute [flow].
 - (mgd) - Mega Gallons per day [flow].
 - (cfm) - Cubic Feet per minute [flow].
 - (cfs) - Cubic feet per second [flow].
 - (l/min) - Liter per minute [flow].
 - (l/s) - Liter per second [flow].
 - (m³/h) - Cubic meters per hour [flow].
 - (Ml/d) - Mega liters per day [flow].
 - (Imp gpm) - Imperial Gallons per minute [flow].
 - (bar) - Bar [pressure].
 - (kPa) - Kilopascals [pressure].
 - (Mhd) - Mega Hectares per day [flow].
 - (psi) - Pounds per square inch [pressure].
 - (m) - Meters of water [pressure].
 - (in) - Inches of water [pressure].
 - (ft) - Feet of water [pressure].

- (%) - Percentage [unit-less].
- (h) - Hours [time].
- (min) - Minutes [time].
- (s) - Seconds [time].
- (gal) - Gallons [volume].
- (mg) - Mega gallons [volume].
- (cf) - Cubic feet [volume].
- (l) - Liters [volume].
- (m3) - Cubic meters [volume].
- (Ml) - Mega liters [volume].
- (mA) - Milliamps [electrical flow].
- (Volt) - Volts [electrical potential].
- **"Decimal"**: Select from available decimal places:
 - 0
 - 0.0
 - 0.00
- **"Signal Type"**: Select from available signal types (to be updated to include more signal types in the future):
 - 4-20 mA.
- **"4mA ="**: Set the value of the input at 4 mA; usually this will correspond to a value of 0.
- **"20mA ="**: Set the value of the input at 20 mA; this should correspond to the maximum measured value.
- **"Default Value"**: When the 4-20 mA loop is broken, this is the value that is used.
- **"Ramping"**: Ramping speed to reach the value.

3.4.3 CONFIGURE "VARIABLES" MENU

The buttons highlighted below enable the creation of new variables and the sorting of existing ones.

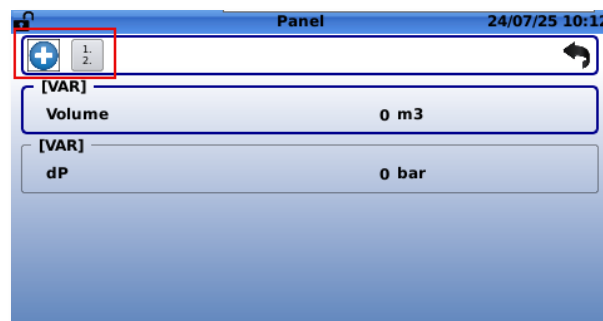

3.4.4 "VALVE CONFIGURATION" MENU

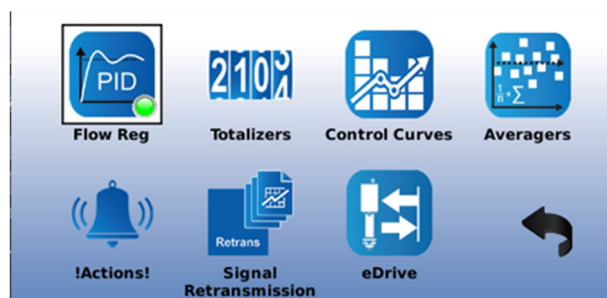

The "Valve Configuration" screen includes the regulation blocks related to the loaded **ValvApps™**. Regulation blocks can be of the following types:

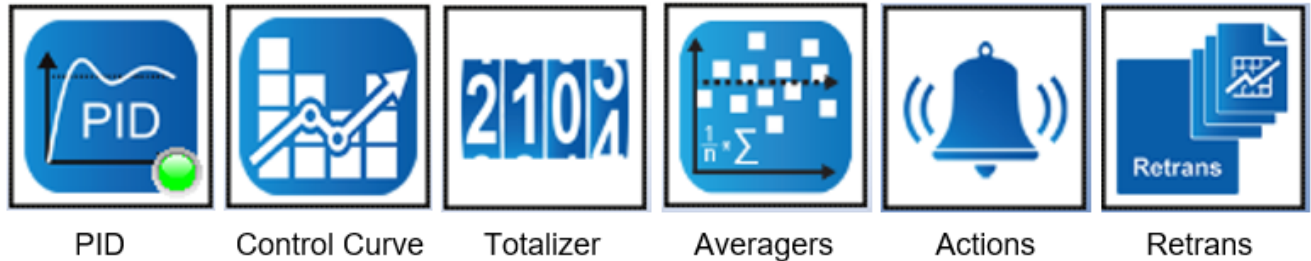

- "PID" (Proportional-Integral-Derivative):**
 The "PID" regulation maintains the valve at a configured set-point. Up to four (4) "PID" regulation loops can be programmed, each of them offering local or remote set-point capability. Real-time chart view helps to visualize valve response and fine tune the electronic valve controller accordingly. Perfect valve control is achieved by CLA-VAL features such as programmable set-point ramping to prevent hydraulic shocks.
- "Control Curve":**
 The "Control Curve" offers an easy way to create a relationship between 2 system variables. Using graphical functions, the user draws the "Control Curve" relationship linking pressure, flow, level and/or time directly on the electronic valve controller screen. Up to four (4) "Control Curves" can be profiled allowing specific adaptation such as seasonal adjustment.
- "Totalizer":**
 The "Totalizer" offers the possibility to measure and track the total amount of the fluid which passes through the valve. It is possible to configure and use up to 4 "Totalizers".
- "Averagers":**
 The "Averager" is an algorithm used to calculate the average value of a set of data points or measurements. It offers the possibility to calculate the average per minute, hourly or weekly. It is possible to use up to 4 "Averagers".
- "!Actions!":**
 Used to take action (or alarms) when a programmable condition is met by forcing an output (relay, solenoid, 4-20 mA). The closing relay can be used to send an alarm to a supervision system. Up to four (4) "!Actions!" can be programmed including appropriate hysteresis or dead band configuration.
- "Signal Retransmission":**
 Used to retransmit any input signal, variable, or calculation to a supervision system. Up to four (4) input signals, such as pressure, flow, or level can be redirected through the 4-20 mA outputs. Pulses received from a flow meter are converted into a 4-20 mA signal and retransmitted.

3.4.4.1 Valve Configuration - "PID" Menu

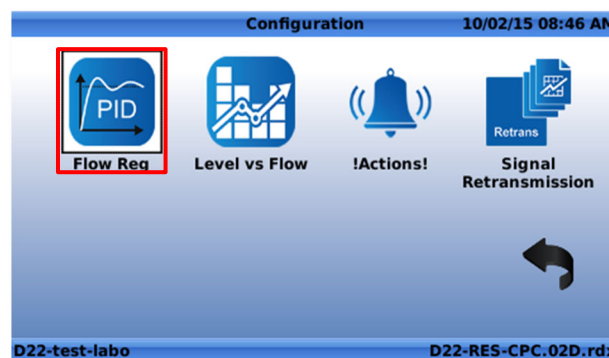

3.4.4.1.1 "General" Tab

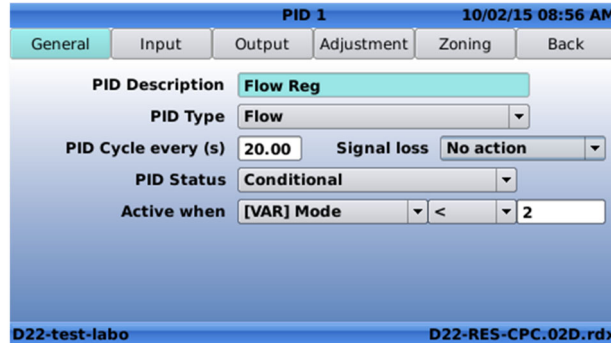

Field Description:

- **"PID Description"**: Use this field to choose a unique name for each PID loop.
- **"PID Type"**: Designate what type of control is being used.
 - **"Flow"**: Control using flow SetPoint and Feedback.
 - **"Pressure"**: Control using pressure SetPoint and Feedback.
 - **"Level"**: Control using level SetPoint and Feedback.
 - **"%"**: Control using percentage open (position of the valve) SetPoint and Feedback.
 - **"Analog"**: Control using flow SetPoint and Feedback.
- **"PID Cycle every (s)"**: This field designates how often the calculation will be done to determine the appropriate action to be taken with the output.
- **"Signal loss"**: This field designates what action the controller will take when there is a loss of signal on the Remote Set Point (RSP). The options are:
 - **"No Action"**.
 - **"Open 100%"**: Open valve 100%.
 - **"Close 100%"**: Close valve 100%.
 - **"Lock Position"**: Maintain valve in current position.
- **"PID Status"**: The user may configure a PID loop, but not activate it until the appropriate time. The choices are:
 - **"On"**: The regulator is always active.
 - **"Off"**: The regulator is not active.
 - **"Conditional"**: When the **"Conditional"** option is chosen, an additional field appears and prompts the user to specify when the PID should be active. The following field is shown:

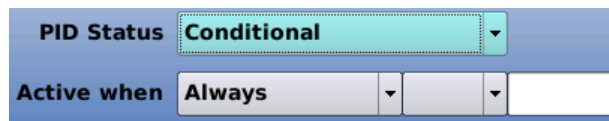

The PID loop can be configured to be active - Always, or when one of the inputs meets a certain condition. In this case, use the pull down menu that is defaulted to "Always" to select the appropriate input, then use the pull down menu to the right to select an operator, such as the **"Greater than"** sign (>), then specify a value.

Example: The following PID loop has been set to be conditional active, only when the Feedback [AI2] is greater than 50.00 l/s.

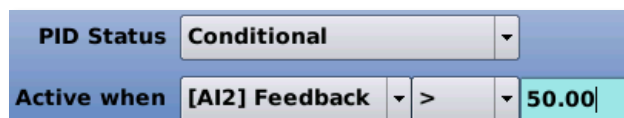

3.4.4.1.2 "Input" Tab

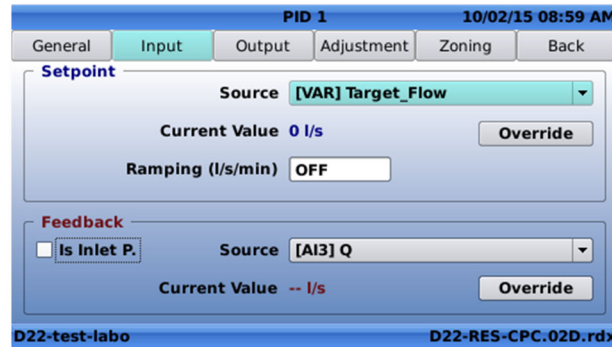

Field Description:

- **Setpoint Section:**
 - **"Source"**: Designates which compatible input or variable is to be used as the Setpoint for the PID loop.
 - **"Current Value"**: Shows the *live* current value of that input.
 - **"Override"**: Allows the user to input an override value from this menu rather than having to go back to the input information or input configuration screens - this can be helpful when commissioning a system for the first time.
 - **"Ramping (l/s/min)"**: Gradually varying the value when the set point changes rapidly [either by **"Remote Set Point"** Changes or **"Local Set Point"** (override) changes].
- **Feedback Section:**
 - **"Source"**: Designates which input is to be used as the feedback for the PID loop.
 - **"Current Value"**: Shows the *live* current value of that input.
 - **"Override"**: Allows the user to input an override value from this menu rather than having to go back to the input information or input configuration screens - this can be helpful when commissioning a system for the first time.

3.4.4.1.3 "Output" Tab

Allows to configure the output on which the regulation is done.

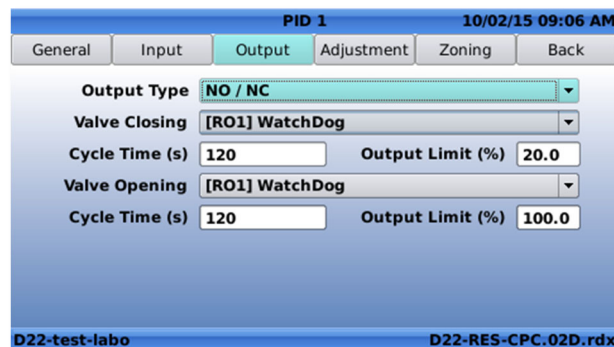

Field Description:

- **"Output Type"**: Designates what type of output is used. Pick in the dropdown menu from the following:
 - **"NC/NC"**: NC = Normally Closed (Closing Sol / Opening Sol).
 - **"NO/NO"**: NO = Normally Open (Closing Sol / Opening Sol).
 - **"NO/NC"**: Normally Open (Closing Sol) / Normally Closed (Opening Sol).
 - **"Linear 4-20mA"**: Will vary the Analog Output (4-20 mA) according to the PID loop.
 - **"Linear -> VAR"**: Will vary the internal variable according to the PID loop.
- **"Valve Closing"**: Designates which of the solenoid outputs [SO1] or [SO2] will be used to close the valve.
- **"Cycle Time (s)"**: Designates the total cycle of action for the **"Valve Closing"** solenoid:
 - **"Output limit (%)"**: Designates valve closing limit.

- "Valve Opening": Designates which of the solenoid outputs [SO1] or [SO2] will be used to open the valve:
 - "Output limit (%)": Designates valve opening limit.
- "Cycle Time (s)": Designates the total cycle of action for the "Valve Closing" solenoid.

3.4.4.1.4 "Adjustment" Tab

The "Adjustment" tab offers the possibility to configure the regulator coefficients and some other parameters of the PID.

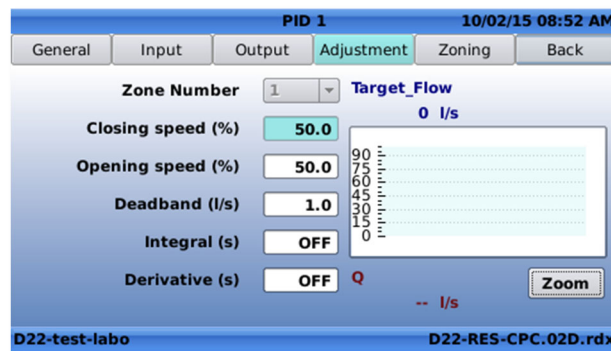

Field Description:

- "Zone Number": Designates which PID loop is being adjusted; at any time, up to 4 PID loops may be used.
- "Closing Speed (%)": Designates how quickly the valve will be able to close. 1% is the slowest possible, 99% is the fastest possible.



Note: Actual time to close will depend on the hydraulic conditions.

- "Opening Speed (%)": Designates how quickly the valve will be able to open. 1% is the slowest possible, 99% is the fastest possible.



Note: Actual time to open will depend on the hydraulic conditions.

- "Deadband (l/s)": Designates where the controller will take no action because it is close to the SetPoint.

Example: If the setpoint is 50 l/s and the deadband is set at 2 l/s, then the controller will take no action on the feedback value from 48 l/s to 52 l/s

- "Integral (s)": This value is used for fine tuning of very sensitive systems.



It is not recommended that this be used without contacting CLA-VAL Technical Support!

- "Derivative (s)": This value is used for fine tuning of very sensitive systems.



It is not recommended that this be used without contacting CLA-VAL Technical Support!

3.4.4.1.5 "Zoning" Tab

This tab allows the creation of up to four distinct regulation zones based on a specified input or variable. Each zone can be configured with different opening and closing speeds, as well as variable deadbands. It is important to note that the regulator coefficients remain constant from one zone to another.

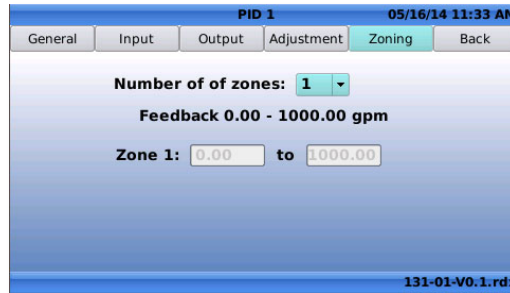

Field Description:

- "Number of zones": Designates how many PID zones are to be created (max 4).



Note: When multiple PID loops are created, the active region for each is designated by an equal division of the total feedback range, see example below:

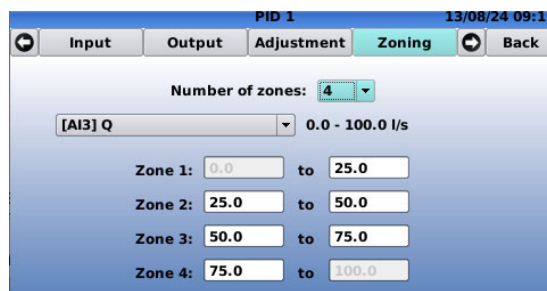

The active region for zones 1, 2, 3 and 4 are each one quarter of the total feedback range. These values can be specified by changing the values in each zone, according to the needs of the user.

- "Zone 1": designates the top of the range for zone 1 (bottom range is bounded by the low level of the feedback scale).
- "Zone 2": designates the bottom and top range for zone 2.
- "Zone 3": designates the bottom and top range for zone 3.
- "Zone 4": designates the bottom range for zone 4 (top of the range is bounded by the high level of the feedback scale).

3.4.4.1.6 "R/T View" Tab

The "R/T View" tab provides a real-time graphical representation of the regulation process. It offers valuable insights into the system's performance by displaying real-time information on setpoints, feedback on commands, and ongoing actions. Users can monitor and analyse the regulation process efficiently, enabling them to make informed decisions and adjustments as needed. With the "R/T View" tab, users can gain a comprehensive understanding of the system's behaviour and performance dynamics, enhancing overall control and efficiency.

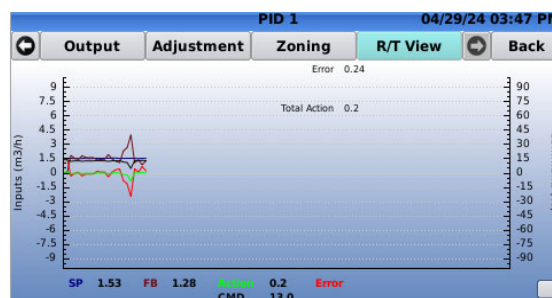

3.4.4.2 Valve Configuration - "ValveFlow" Menu

ValveFlow is a feature designed to calculate the flow rate passing through a valve, given the upstream and downstream pressures, as well as the valve opening. By utilizing this feature, it is possible to accurately determine the flow rate within a pipeline system, enabling precise control and optimization of fluid dynamics.

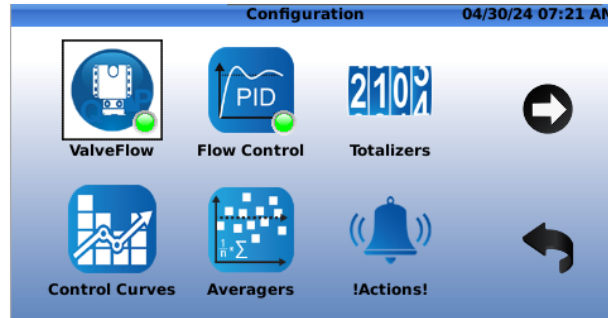

3.4.4.2.1 "Valve" Tab

In this tab it is possible to choose the valve type and its parameters and some other parameters see the "Field Description" below.

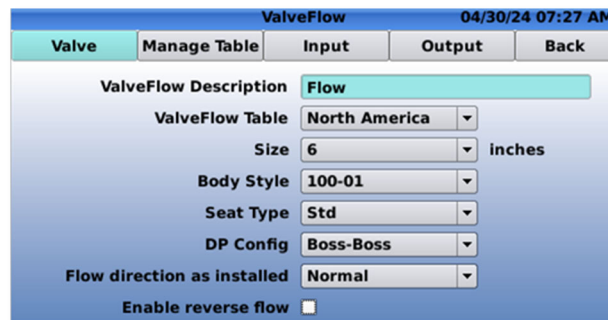

Field Description:

- **"ValveFlow description"**: Designates the name of the ValveFlow.
- **"ValveFlow Table"**: Designate the table to be used.
- **"Size"**: Designate the size of the valve that is being used. Options are different depending on the "ValveFlow table that is being used.
- **"Body Style"**: Designate the body style of the valve. Options are:
- **"Seat Type"**: Designate the type of seat of the valve. Options are:
- **"DP Config"**: Designate the location of the pressure transducers. Options are:
 - Boss-Boss - Pressure transducers located on the valve.
 - Pipe - Pressure transducers located on the pipe.
- **"Flow direction as installed"**: Designate the flow direction.
 - Normal - Flow goes in the same direction as indicated on the valve.
 - Reverse - Flow goes in the reverse direction as indicated on the valve.

3.4.4.2.2 "Manage Table" Tab

In this tab it is possible to import a new table which can be used to calculate the flow according to the needs of the user.

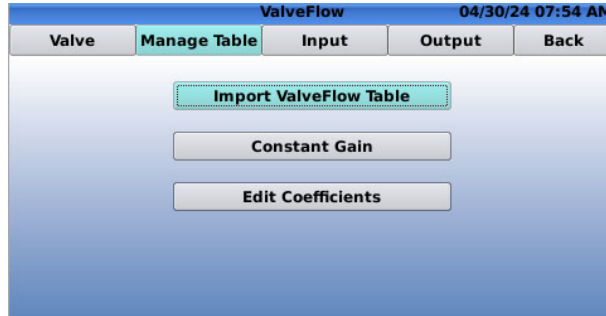

3.4.4.2.3 "Input" and "Output" Tab

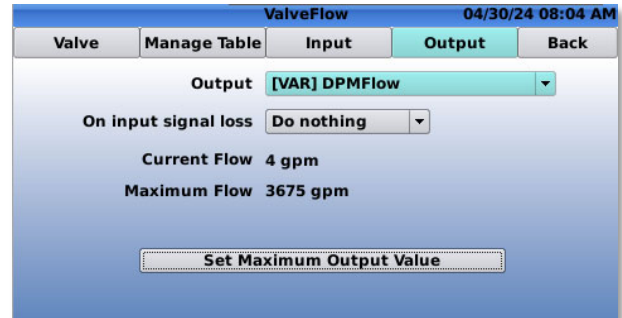
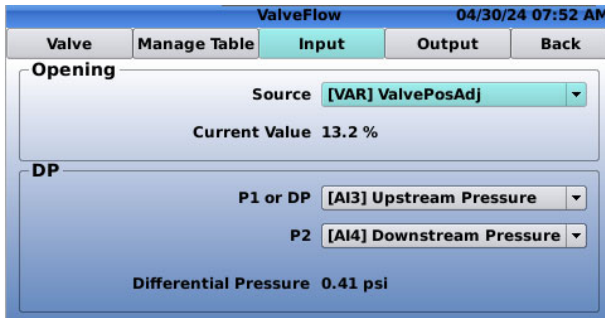

The "Input" tab offers the possibility to define the inputs which will be used for the flow calculations.

The "Output" tab offers the possibility to specify the variable in which the calculated flow will be stored and also it is possible to define the maximum flow which can be calculated.

3.4.4.3 Valve Configuration - "Control Curve" Menu

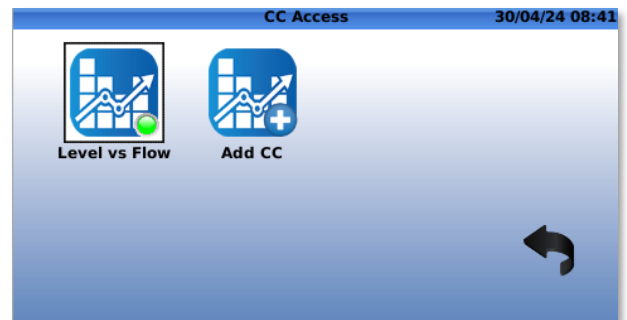
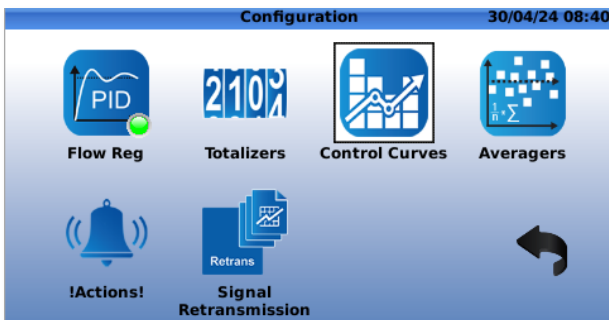

3.4.4.3.1 "General" Tab

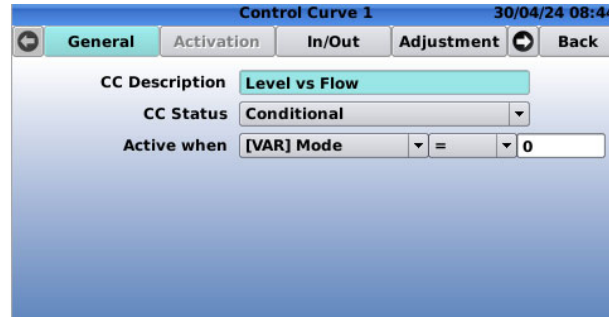

Field Description:

- **"CC Description"**: Designate a name for the custom control curve.
- **"CC Status"**: Designate whether the control curve is active.
 - **"On"**: The control curve is active.
 - **"Off"**: The control curve is inactive.
 - **"Calendar"**: The control curve is activated according to calendar rules, which are defined in the **"Activation"** tab.
 - **"Period"**: The control curve is activated according to précised period, the period is defined in the **"Activation"** tab.
 - **"Conditional"**: Condition based on an input or variable, as defined in the **"Active when"** field.
- **"Active when"**: Designate the rule for the conditional activation.

3.4.4.3.2 "Activation" Tab (only for Calendar & Periodic Activation)

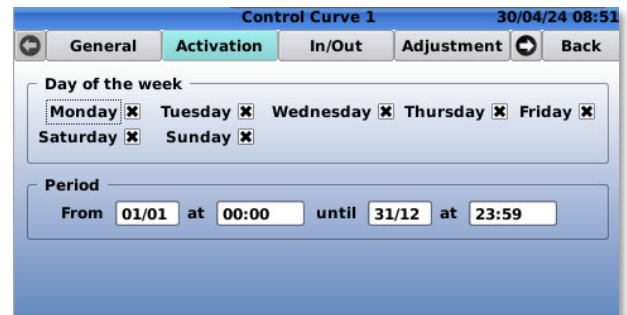



This tab is used only when the activation of the control curve is made on calendar or periodic bases. It is possible to choose between varying activation options.

Field Description:

- **"Day of the week"**: Designate which day(s) of the week the custom control curve is active.
- **"Month of the year"**: Designate for which months the days selected are considered.
- **"Period"**: Designate the period during which the CC is active.

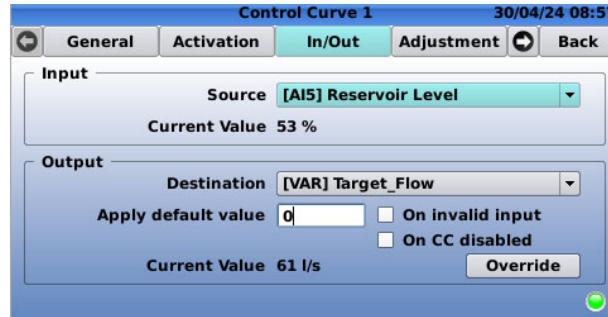
3.4.4.3.3 "In/Out" Tab



Field Description:

"Input" Section:

- **"Source"**: Designate the input flow signal location.

"Output" Section:

- **"Destination"**: Designate the analogue output location for the motorized control.
- **"Apply default value"**: Define a default value to the output in case of an invalid entry or when the CC is not active.
- **"Override"**: Override the output in **"Designation"** with a custom value.

3.4.4.3.4 "Adjustment" Tab

The following tab is used to configure the control curve. In this tab it is possible to add or remove points, as well as change the transition mode between points (slope or step). Additionally, the modifications made can be observed in graphical form.

The arrow located at the bottom-left corner indicates the direction in which the graph should be read:

1. Standard: the input is on the X-axis (in this case, Target Flow) and the output on the Y-axis (in this case, Reservoir/Tank Level).
2. Reverse: the input is on the Y-axis (in this case, Reservoir/Tank Level) and the output on the X-axis (in this case, Target Flow).

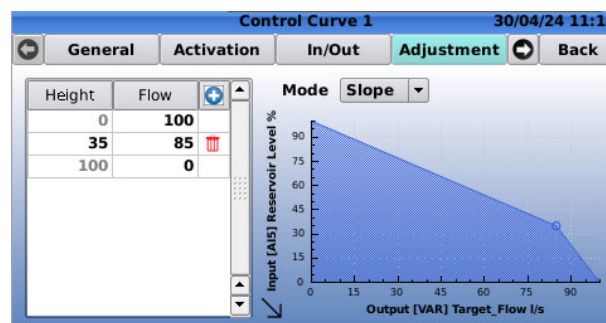

The graph on the right describes the relationship between the reservoir level and the flow setpoint, indicating that as the reservoir level increases, the flow rate decreases. From the above graph, it is evident that this is a reverse control curve.

The control curve can be completely customised from the **"Adjustment"** tab.

Using , it is possible to navigate between each of the points on the table. The currently selected point is filled in red, while other points are not filled.

- **"Edit a point"**: To edit a point you need to be positioned on the point to be changed and the click on (Home/OK). The selected point becomes red and the value can be modified.
- **"Add new point"**: To add a new point you need to click (Home/OK) on the (+) and then insert the desired value.
- **"Delete a point"**: To erase a point you should click on the red bin next to the desired value.

3.4.4.3.5 "R/T View" Tab

This tab offers the possibility to observe real-time variations in the control curve. The green button in the bottom-right corner indicates that the control curve is active, allowing users to monitor changes dynamically as they occur.

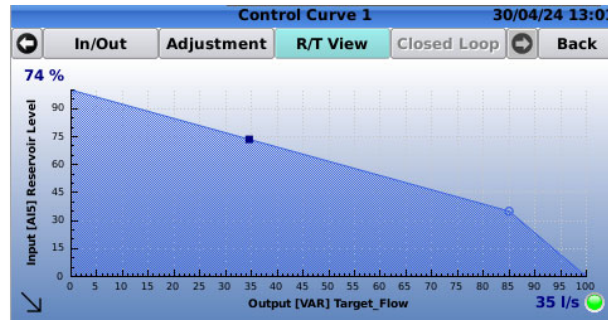

3.4.4.4 Valve Configuration - "Totalizer" Menu

This tab gives the possibility to create and configure a totalizer.

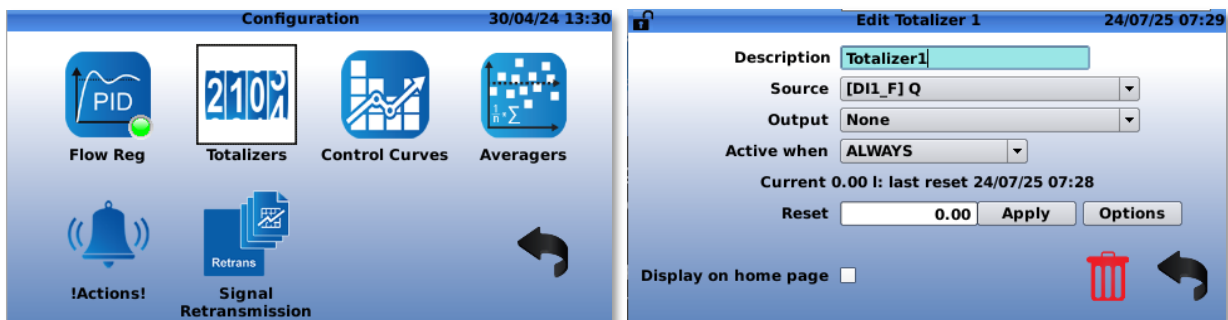

Field Description:

- **"Description"**: Designates the name and the description of the totalizer count.
- **"Source"**: Designates which input should be used as the source for the totalizer count.
- **"Output"**: Designates where the total should be sent after it is calculated.
- **"Active when"**: Designates when the totalizer should be active.
 - **"Always"**: The totalizer will always be on.
 - **"[Aix, Dix, Var]"**: Conditional based on input or variable.
- **"Reset"**: Offers the possibility to reset the totalizer to 0 or to a given value. The reset can be configured to occur:
 - **"Manually"**: By the user via the interface
 - **"Automatically"**: On a daily, weekly, monthly or yearly basis
 - **"Conditionally"**: Based on a digital input or an analog input
- **"Display on home page"**: By checking the box it is possible to show the totalizer on the home page.

3.4.4.5 Valve Configuration - "Actions" Menu

In this tab it is possible to create and configure alarms which give the possibility to force an output or variable in function of an input value, variable or time.

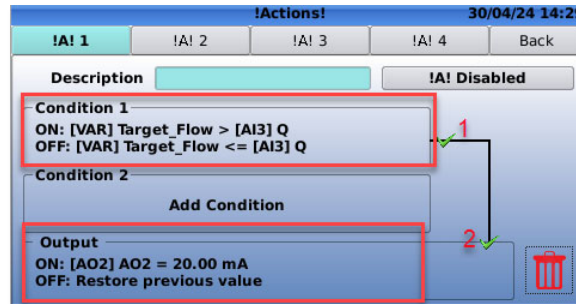

Field Description:

- **"Description"**: Use this field to choose a unique name for each action.
- **"IA! Enabled"**: Designates that this action is enabled or disabled.

To configure an action, follow the steps below:

1. Click  on the **"Condition 1"** to configure the condition.

In the **"Condition"** menu, configure the condition when and how to apply the action.

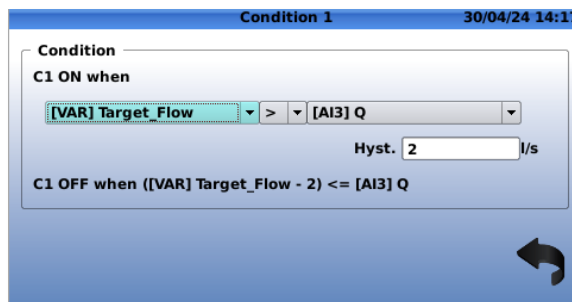

Field Description:

- **"C1ON when"**: Conditional field that designates when this action is active, according to the value and operator used.
- **"Hysteresis"**: Set up a hysteresis.

Go back to the **"Actions"** menu and then click  on the **"Output"** to configure the output(s) on which the action will be executed. It is possible to select up to two outputs for a single action

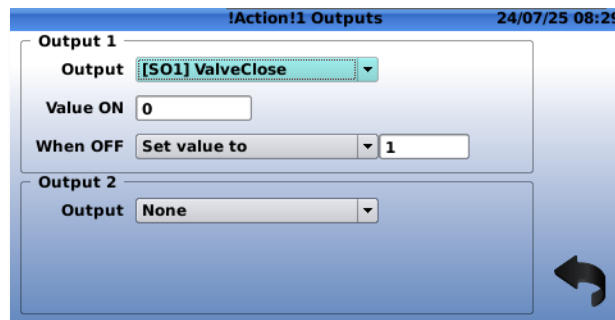

Field Description:

- **"Output"**: Designates on which of the outputs to act.
- **"Value ON"**: Designates the value to apply to the selected output.

- **"Default"**: Designates the default value of that action - which will be applied while the action is in the "OFF" state.
- **"Delay Options"**: Offers the possibility to apply the action with a delay.

It is possible to configure two conditions and utilize a logical operator such as **"AND"** or **"OR"** to activate the action.

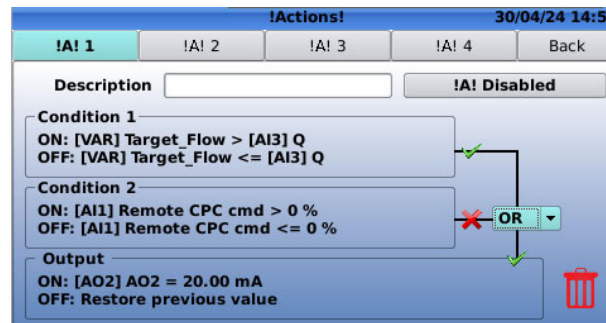

The  icon is displayed when a condition is filled, and the  when it is not filled.

3.4.4.6 Valve Configuration - "Averagers" Menu

The **"Averagers"** tool allows the user to calculate and display the average value over an input or variable. This tool offers the possibility to stock the average value of a given input or variable into a new variable.

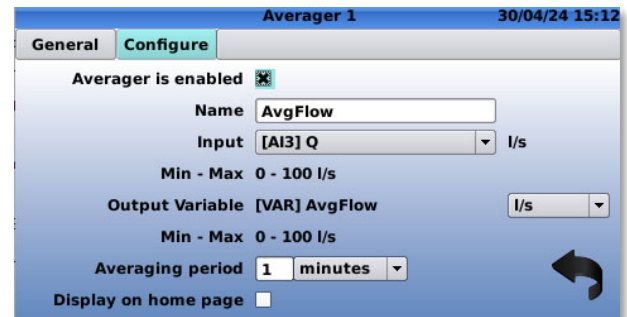
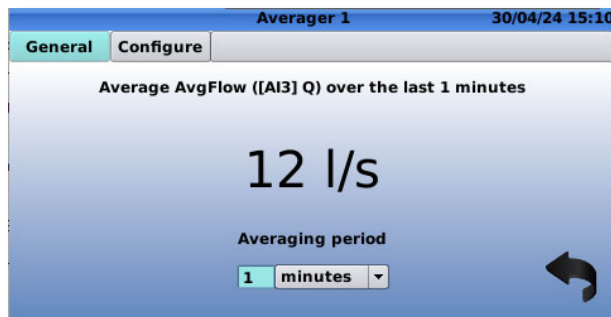

3.4.4.6.1 "General" Tab

In this tab it is possible to view the real-time value of this average and also choose the time interval over which the average is calculated.

3.4.4.6.2 "Configure" Tab

This tab allows to configure the averaging. Details of the fields are as follows.

Field Description:

- **"Name"**: Designates the name of the variable which will contain the calculated average.
- **"Input"**: Designates the input on which the average will be calculated.
- **"Output Variable"**: Shows the variable which will contain the calculated average and its unity.
- **"Averaging period"**: Offers the possibility to choose the time interval over which the average will be calculated.
- **"Display on home page"**: By checking the box the average variable will be displayed on the home screen.

3.4.4.7 Valve Configuration - "Signal Retransmission" Menu

The "Signal Retransmission" tool allows the redirection of an input signal or a variable signal to an output.

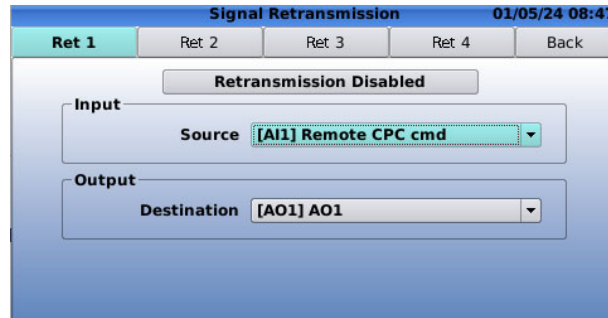

Field Description:

- "Retransmission Disabled": Designates if the retransmission is enabled or disabled.
- "Source": Designates the analogue input or the variable from which the signal will be retransmitted.
- "Destination": Designates the analogue output on which the signal will be retransmitted.

3.4.5 "SETTINGS" MENU

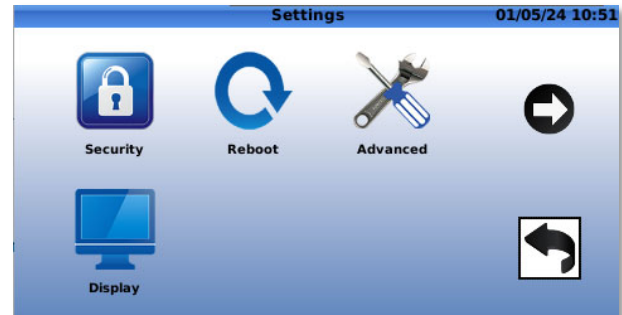
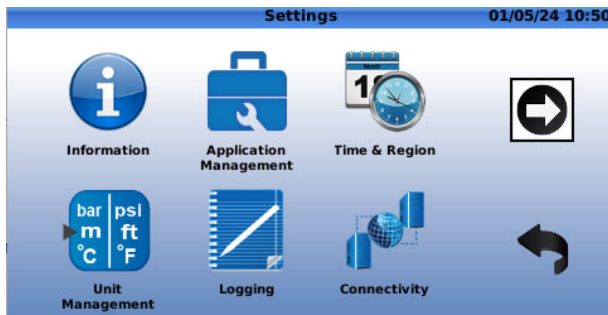

3.4.5.1 "Information" Page

3.4.5.1.1 "Identification" Tab



Device identification information with "S/N (IMEI)" the serial number of the device, and "SIM (ICCID)" the SIM card identification number.

Field Description:

- "S/N (IMEI)": the serial number of the device.
- "HostName": Use this field to assign a host name to the device. The default host name of the device is of the form *D22-serial number*.

- **"Contact"**: Use this field to enter an email valid email address for the use of the *Link2Valves*™ data visualisation web interface.
- **"Location"**: Use this field to enter the location of the device.
- **"Order ID"**: Use this field to enter the Order ID.

3.4.5.1.2 "Version" Tab

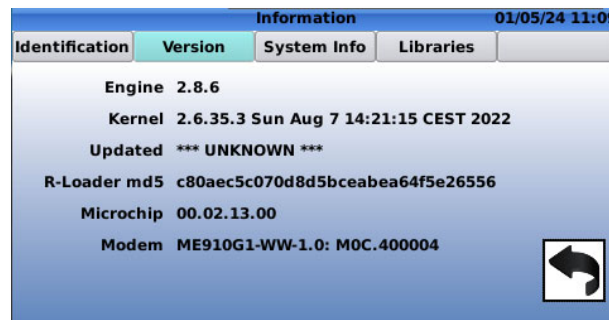

This page shows information about the version of the operating software installed on the device, updates and modem version.

3.4.5.1.3 "System Info" Tab

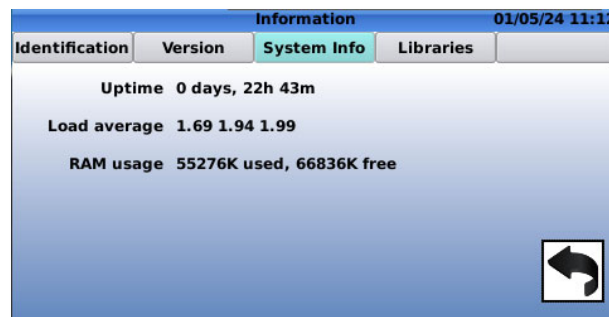

This page shows information about various system settings, such as Uptime or RAM usage.

3.4.5.1.4 "Libraries" Tab

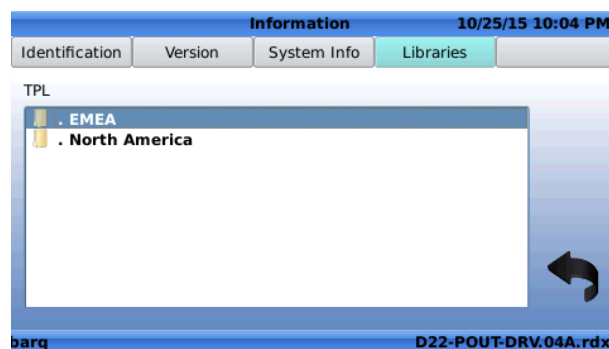

This tab contains the libraries of the standard *ValvApps*™.

3.4.5.2 "Application Management" Page

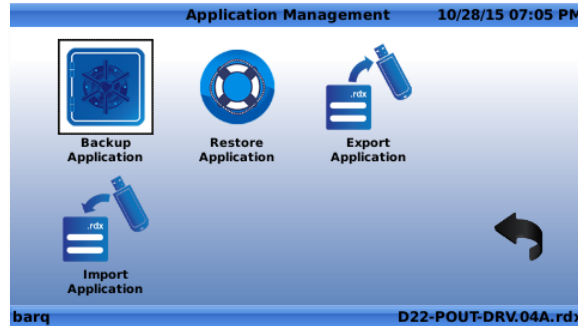

3.4.5.2.1 "Backup Application"

When the **"Backup Application"**  icon is selected, the following dialog boxes appear:

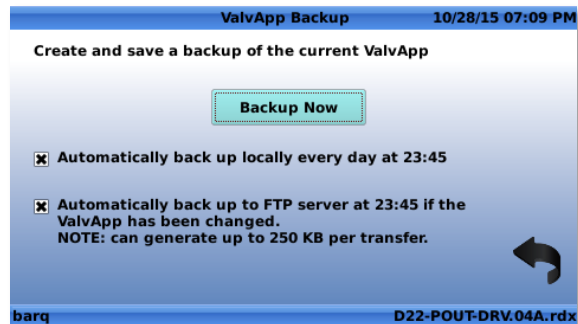

- **"Backup Now"**: Click on this button to manually back up the application.
- **"Automatically back up locally every day at 23:45"**: Check (resp. un-check) the box to activate (resp. deactivate) an automatic backup of the current **ValvApps™** stored locally in the machine daily.
- **"Automatically back up to FTP server at 23:45 if the ValvApps has been changed"**: Check (resp. un-check) the box to activate (resp. deactivate) an automatic backup of the current **ValvApps™** stored to the configured FTP server. This back up will happen only if the **ValvApps™** has been modified.

 This function can generate important data transfer (up to 250 kB) depending on the application.

3.4.5.2.2 "Restore Application"

When the **"Restore Application"**  icon is selected, the following screen appears, showing the available **ValvApps™** that can be restored:





In the directory screen, click the



button to navigate to the parent directory.



Select the appropriate file to restore, then click . The following dialog box will appear to confirm your choice:

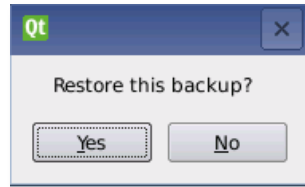

Select **"Yes"** to restore to the chosen backup file. Select **"No"** to cancel the backup. If selected **"Yes"** then choose the options that suit better depending on cases.



3.4.5.2.3 "Export Application"



To use the functionality of the **"Export Application"** function, ensure that either a USB stick is inserted into the USB-A

Slot of the D22 Electronic Controller, and/or an FTP server is setup in the device. When the **"Export Application"** icon  is selected, the following screen appears:





The USB option gives the possibility to export the application to the directory of the connected USB stick, the FTP option enables the user to export the application to an FTP server.

3.4.5.2.4 "Import Application"

 To use the functionality of the "Import Application" function, ensure that a USB Flash drive or is inserted into the USB-A slot of the Electronic Controller, and/or an FTP server is setup in the device.

When the "Import Application"  icon is selected, the following screen appears to show the directory of the USB drive inserted into the electronic controller and the library of the Standard **ValvApps™**.



: In the directory screen, use the buttons  ,  to navigate into different repertoires and find the desired **ValvApps™**

Click the  button to load the selected file. Then choose the options that suit better depending on cases.

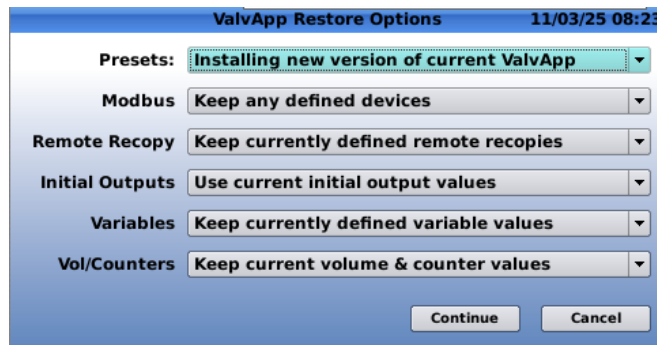

3.4.5.3 "Time & Region" Page

3.4.5.3.1 "Time Zone" Tab



In this tab is possible to choose the time zone, the country, the region and it is also possible to choose to automatically adjust for the daylight-saving time.

3.4.5.3.2 "Data and Time" Tab

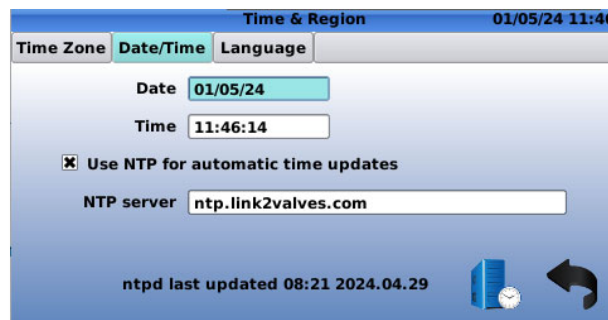

Offers the possibility to manually set the date and the time or to automatically do it by taking the updates from the NTP.

To perform an automatic update, simply click on the following icon. 

3.4.5.3.3 "Language" Tab

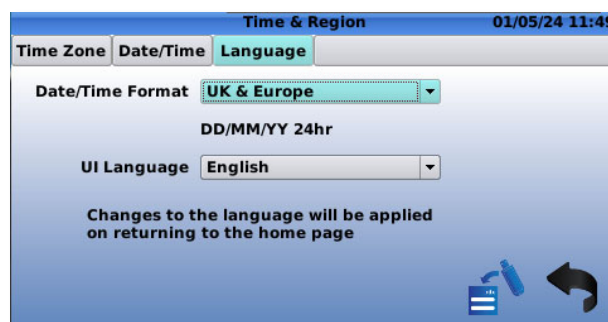



In this tab, the user can choose the date and time format and change the language of the device.

3.4.5.4 "Logging" Page



3.4.5.4.1 "Configuration"

 **It is recommended to not change the logging parameters without assistance of an official CLA-VAL representative.**

Select the icon  to enter the "Log Server Configuration" menu.

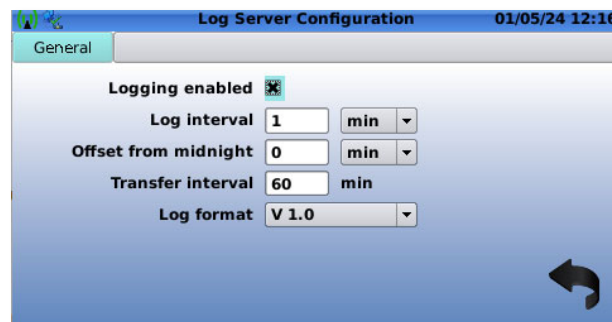

- **"Logging enabled"**: Check (resp. un-check) the box to activate (resp. deactivate) the logging of data.
- **"Log interval"**: Defines the frequency at which data are saved in the internal memory of the device.

 Interval of less than a minute can result to a rapidly overload of the memory.

To activate the fast logging, you need to contact CLA-VAL.

- **"Transfer interval"**: Defines the frequency at which saved data are transferred to the server that has been configured in the device.

- **"Log format"**: Designates which format to use for the log files.
 - **"V1.0"**: Complete log format for devices with an R-Engine software version 1.7 or higher.
 - **"Legacy"**: Allows to generate log files compatible with log files of devices with R-Engine software version lower than 1.7.

 An interval of less than one minute can quickly lead to memory overload.

3.4.5.4.2 "Export"

Select the icon  to export log files to a USB drive or FTP server.



Choose from one of the options and then click on  to finalize the exporting of the logs.

3.4.5.5 "Unit Management" Page

In this page, it is possible to choose the units for the parameters used in the controller.

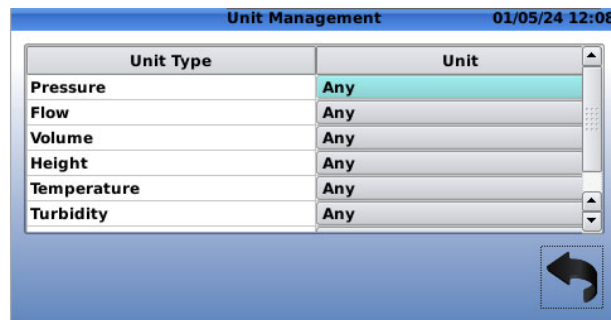

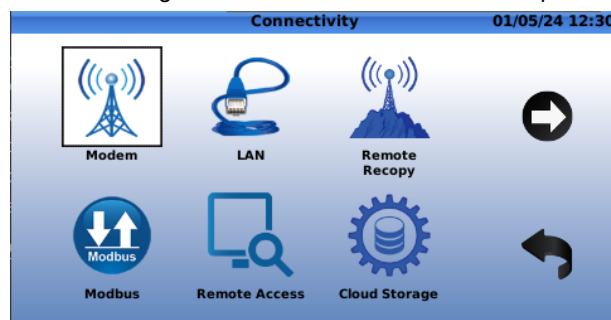

3.4.5.6 "Connectivity" Page

This page contains multiple menus for the configuration of different communication protocols.





3.4.5.6.1 "Modem Connectivity" Page

 To use the cellular network functionality, ensure that a valid SIM card is inserted in the cover part of the Electronic Controller (see section §2.2.3 of this manual).

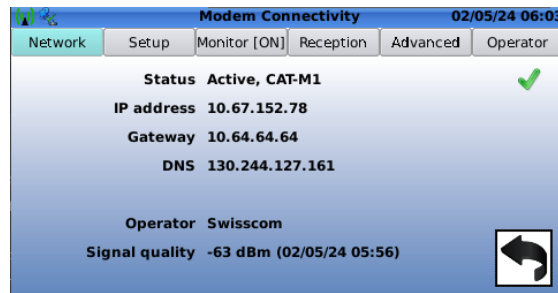
When "Modem"  icon is selected, the following screen appears:



- "Network" tab: Provides general information about the cellular network connectivity.

: The  icon is displayed if the device is connected, and the icon  when the device is not connected.

- "Setup" tab:

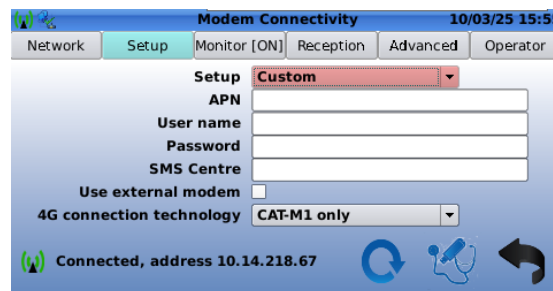

- "Setup": Allows the user to choose between CLA-VAL (if a CLA-VAL Sim card is used) or Custom if other Sim cards are used, then the other fields must be filled with the right information provided by the network operator.
- "4G connection technology": Offers the possibility to choose between numerous options of communication (4G CAT-M1 or NB-Iot) depending on the coverage constraints, geographical situation of the device, and the user's preferences.
- "Refresh ": With a click on the 'Refresh' button, the modem will automatically reboot and reconnect to the network. This process ensures that the modem establishes a fresh connection to the network, which can help resolve connectivity issues or update network settings. Please note that during the reboot process, the modem may temporarily lose connectivity, so it is advisable to perform this action during a time when network interruption is acceptable.
- "Modem Diagnostic - USB stick icon": Allows the user to export the modem diagnostics logs for troubleshooting and analysis. The logs contain detailed information about the modem's status, connectivity, signal strength, and error messages, helping to diagnose and resolve potential issues.



- "Monitor [ON]" tab: In this tab, it is possible to choose when resetting the modem automatically.

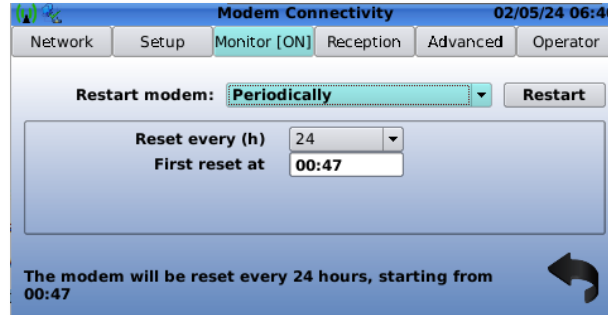

- "Never": The modem will not restart.
- "Connection to target lost": Designate a known IP address "Ping Target" to target for the modem to check at a regular interval defined in "Interval (min.)" if the communication failed. After a number of unsuccessful tries defined in "Retry Count", the communication is considered lost, and the modem restarts.
- "Periodically": Reboot the communication modem periodically as defined in "Reset every (h)" starting at the time set in "First reset at".



Ensure that the target is a valid IP address that is constantly active. Use the "Test" button to check if the connection to the target can be established.

- "Reception" tab: This tab provides information regarding the network and its signal quality.

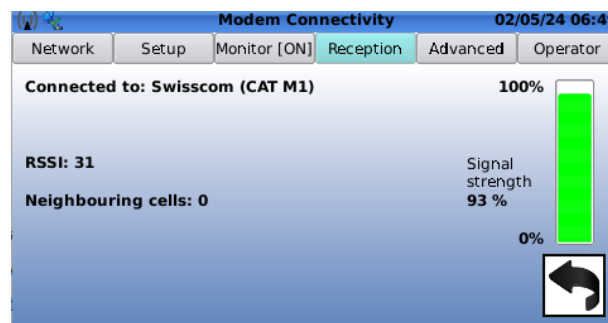

- "Advanced" tab: This tab provides advanced information regarding the cellular network connectivity.

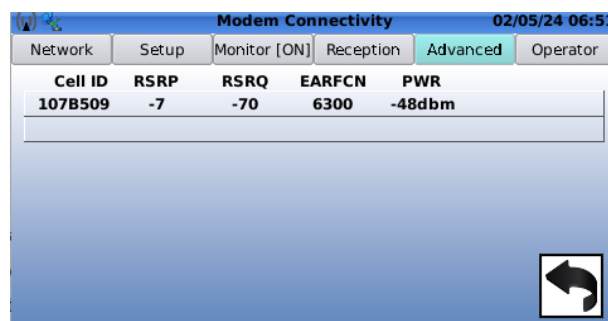

- **"Operator"**: This tab provides a list of operators available on the area where the device is located. It is possible to choose the automatic mode which selects the best operator by default or select the one preferred.

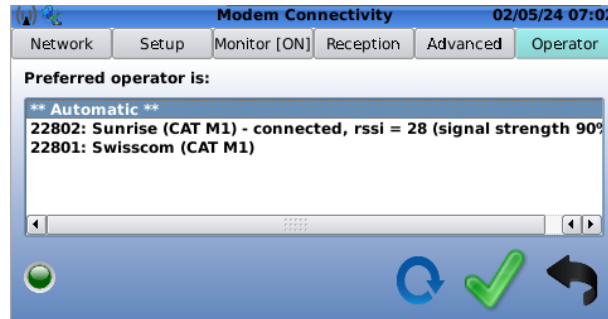

3.4.5.6.2 "LAN"

When **"LAN"**  icon is selected, the screen **"IP Configuration (eth0)"** appears:

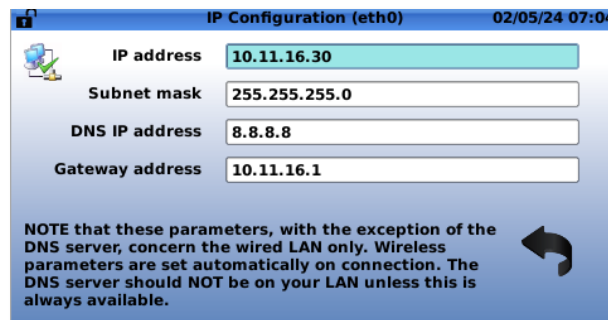



This **"LAN"** window offers the possibility to configure the device to be connected to a local area network.

3.4.5.6.3 "Remote Recopy" page

The **"Remote Recopy"** option allows the user to set up a *peering* functionality, for multiple electronic controllers to communicate together remotely (remote access to inputs, outputs and internal variables).

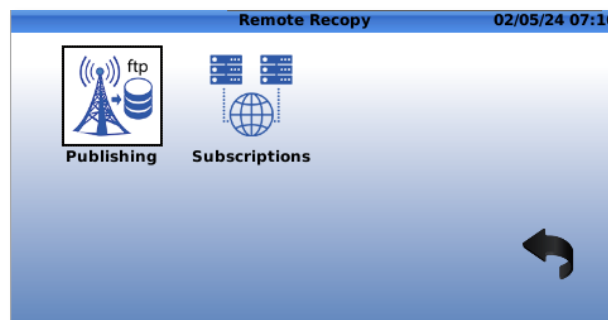

With a click on **"Remote Recopy"**  icon, the following screen appears:



1. In the "Publish"  menu a check on the "Publishing enabled" button allows the remote recopy on the configured FTP server.





The "FTP server" field is then automatically filled with the FTP server set in the device. The FTP server access settings can be changed by pressing the  icon.



2. Click the  icon to check the connection to the FTP server. A  "Server access status" confirms a successful connection to the server, while a  indicates a failed connection.

 In this case, please check the FTP server parameters and connectivity.

3. Enter the publishing frequency in the "Publish every" field (minimum 5 seconds).

 : 15 minutes to 60 minutes is probably a good data transfer frequency for most of hydraulic applications.



 : High frequency of data transfers may result in high costs from the operator.

4. Once the publishing is set and validated, export the configuration on a USB stick by clicking the  icon.
5. For each of the devices that need to access the publishing device inputs, outputs or remote variables, click the "Remote Recopy" > "Subscriptions"  icon.



Click on the  icon to add a subscriber and then insert the USB stick with the publishing device configuration (see step d.).

Then import the right file with the  icon.

- Click the  icon to check the connection to the FTP server. A  "Server access status" confirms a successful connection to the server, while a  indicates a failed connection.
- Enter the connection frequency in the "**Refresh time**" field (minimum 5 seconds), and the time to disable tentative connections in case of a connection failure in the "**Timeout**" field.



: 15 minutes to 60 minutes is probably a good data transfer frequency for most of hydraulic applications.





: The connection frequency of the subscribers should be smaller or equal to the publishing frequency of the publisher.



High frequency of data transfers may result in high costs from the operator.

- Go in the input configuration screen to affect a remote value of the "**Publisher**" to one of the inputs of the "**Subscriber**".

Long click  on the  from the home screen and select the input to be affected to a remote value. Then click .

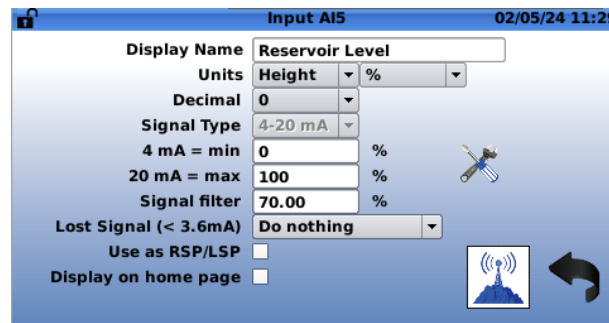

- Click on the  icon and enable the "**Remote recopy enabled**" check box.

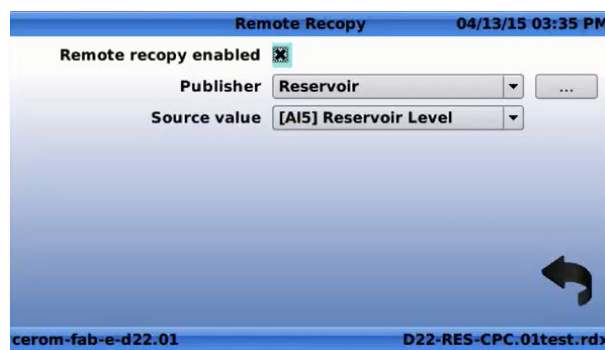

Choose the "**Publisher**" and the "**Source value**" to be peered to.



: Only compatible signals of the "**Publisher**" will be shown in the "**Source value**".

3.4.5.6.4 "Modbus"

Enter in the "Modbus" menu by clicking on the "Modbus"  icon. (à choix : TCP/IP, RS-485, RS-232).

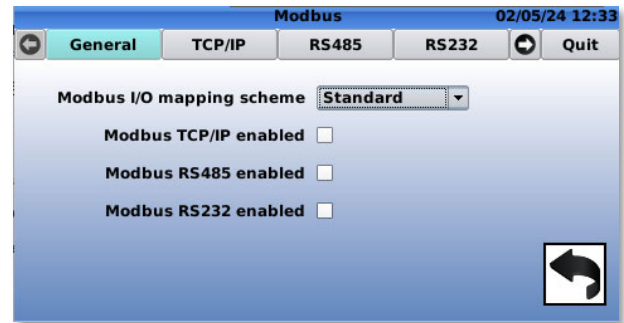
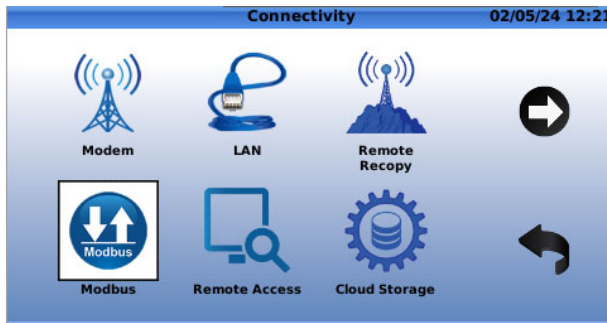

- "General" tab: The "General" tab contains dialogs to enable/disable various types of Modbus communication, as well as the button to choose the mapping scheme.
- "TCP/IP" tab: This tab offers the possibility to configure the Modbus TCP/IP.

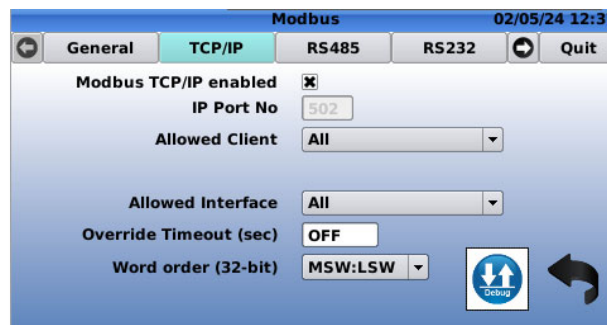

- "Allowed Clients" offers three options: Allow all the clients, allow clients within a specified IP range or allow only a single client.
- "Allowed interface": This button allows to choose the allowed interfaces.
- "Override Timeout": Allows to choose duration of an override via Modbus.
- "Word order": Allows to choose the data representation.
- "Debug icon": Allows to monitor the trace of the Modbus communication, it is also possible to save these logs on an USB-stick.
- "RS485" tab: Offers options for the configuration of the Modbus RS485 which is commonly used for slightly long distances and for multi-point communication.

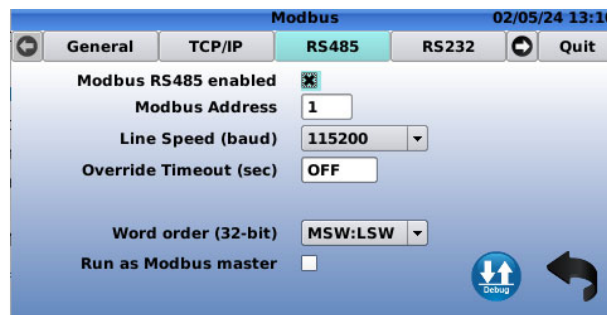

- "Line Speed": Offers flexibility by allowing selection from a range of baud rates, depending on the implementation.
- "Run as Modbus master": If checked, allows the controller to operate as the Modbus master.

- "RS232" tab: Offers options for the configuration of the Modbus RS232 which is used for short distance communication between two devices.

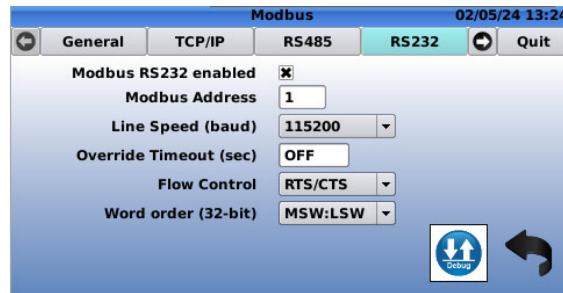

- "Flow Control": Allows to choose how the data is transmitted between the two devices connected. RTS (request to send) and CTS (clear to send).
- "Variable Map" tab: Contains the addresses of the variables. The variables are specific to each valve app and can be modified via Modbus like all other I/Os.

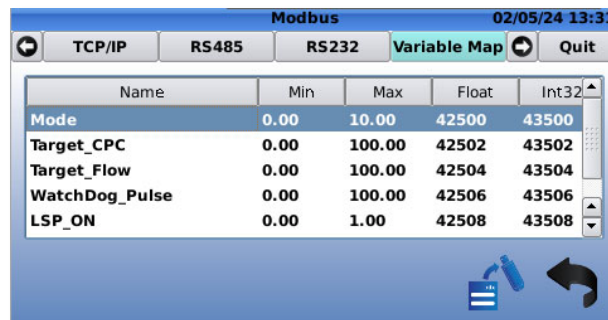

The addresses may vary depending on which mapping scheme is chosen.

- "Devices" tab: Enables the addition of devices communicating with the controller via Modbus, displaying comprehensive information about these devices.

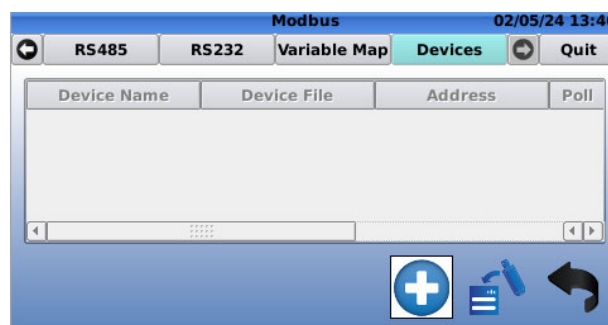

See Chapter 5 «Appendix: Modbus Interface» for more details on how to interface to the Electronic Valve Controller via Modbus.

3.4.5.6.5 "Remote Access"

Enable the remote access to the device via VNC by checking the "VNC enabled" check box:

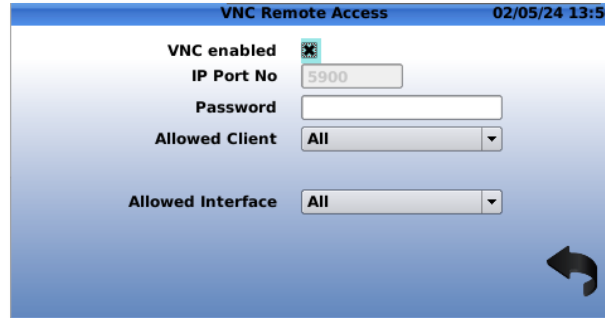

- The remote access can be protected with a password.
- The number of allowed users can be limited.
- Can limit the allowed interfaces.



Required software: the recommended software to access Electronic Controller Remote display is **VNC Viewer™** from **Tight VNC®** (<http://www.tightvnc.com>).

To set a connection via **VNC Viewer™**, follow the steps hereunder:

1. Set the IP address on the computer to 10.11.16.1, Subnetmask 255.255.255.0 of the interface.



: In a **Windows®** environment, for a wired LAN this is usually accessed via the *Control Panel > Network and Internet > Network connections > Local Area Connections > Local Area Connection*.

2. Get the IP address of the Electronic Controller (see chapter 3.4.5.6.2 section 2 of this manual) **From the Home Screen, go to device configuration (Long click down) > Next screen > Reboot.**

3.4.5.6.6 "Cloud Storage – Link2Valves"

- "Configure" tab.



To connect to the CLA-VAL web server and view data on Link2Valves.com, select the Cla-Val Link2Valves option. Then, register using your email address. For more details, refer to Chapter 4.3.3 (insert link).



: If a connection to the CLA-VAL servers is desired, only a valid registration e-mail address is necessary.

- "Test" tab.

This tab offers the possibility to check the connection to the servers.



Go to the "Test" tab to check the connection to the Link2Valves. Click on the  icon to run the test again.

3.4.5.6.7 "Cloud Storage - Link2Valves Gateway"

To connect to the Link2Valves Gateway, select the "L2V Gateway" option. Then, enter the server's name or address and the password.

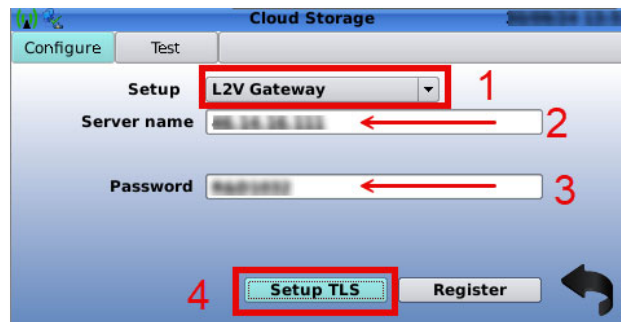

Next, by clicking on "Setup TLS", you can either download the certificate or import it using a USB key.

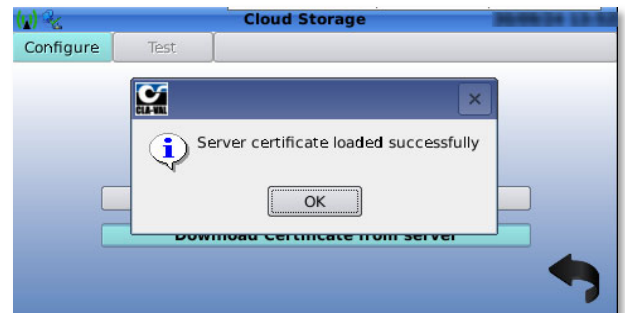

Once this is validated, go to the "Configure" tab and click on "Register" button



 To use the L2V Gateway, the user needs to install in his environment an application dedicated to the L2V Gateway.

3.4.5.6.8 "Cloud Storage - MQTT"

To use MQTT as the communication protocol, select the **"Custom MQTT"** option. In the configuration process, the server's name, username, and password must be provided by the user. The MQTT Client ID for D22 devices follows the format D22-imei of the device. Note that the default port is 1883, unless otherwise specified. The data and configurations are sent to the topics indicated in faded text.

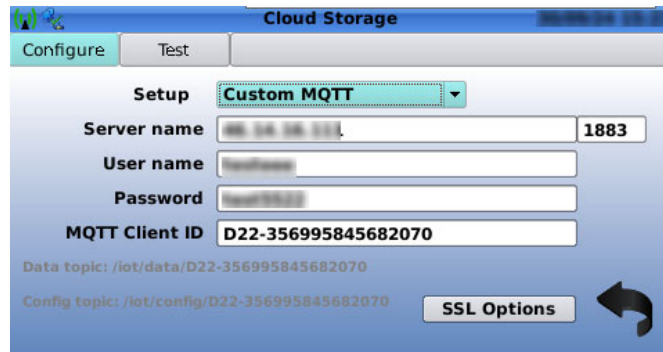

The screenshot shows the 'Cloud Storage' configuration window with the 'Custom MQTT' option selected. The fields are filled with the following information:

- Server name: 192.168.1.100
- Port: 1883
- User name: admin
- Password: admin1234
- MQTT Client ID: D22-356995845682070
- Data topic: /iot/data/D22-356995845682070
- Config topic: /iot/config/D22-356995845682070

An 'SSL Options' button is visible at the bottom right.

After entering all the information, click on **"SSL Options"** to either download the certificate or import it using a USB key.



The screenshot shows the 'SSL Options' configuration window. It displays the following options:

- A server SSL certificate is installed
- Disable server ID verification
- Server port for SSL: 8883
- Buttons: 'Import Server Certificate from USB' and 'Download Certificate from server'

When using MQTT, it is possible to adjust various parameters remotely, such as the recording interval or data transmission interval. Control curves can also be modified, with the option to add or edit points on the control curve, and it is possible to change the values of variables. To modify a parameter or a value, publish a JSON message to the topic: /iot/infos/D22-IMEI. The message format depends on the parameter being changed. Below some examples:

- Modifying the Control Curve via MQTT

```

{
  "profileChanges": [
    {
      "curveId": 3, // Here enter the CC number
      "profile": [
        {
          "X": 4, // The X and Y represents the points on the curve
          "Y": 2.5
        },
        {
          "X": 8,
          "Y": 2.5
        },
        {
          "X": 12,
          "Y": 6
        },
        {
          "X": 15,
          "Y": 12
        },
        {
          "X": 18,
          "Y": 14
        },
        {
          "X": 20,
          "Y": 14.9
        }
      ]
    }
  ]
}

```

- Modifying the Logging Parameters via MQTT

```
{
  "logging":{
    "interval":60,      // Data logging interval in seconds
    "transfer": 1440   // Log Transfer interval in minutes
  }}
}
```

- Modifying the Variables Values via MQTT

```
"settingChanges":[
  {
    "name":"P_SP", // Enter here the name of the variable
    "value":12.0  // Enter here the desired value
  },
  {
    "name":"Pos_SP",
    "value":75.0
  },
  {
    "name":"Q_SP",
    "value":2.0
  }
]
```

- Modifying Action Parameters via MQTT

```
{
  "actions": [
    {
      "id": 1,
      "enabled": true,
      "name": "Alarm1",
      "output": {
        "port": "S01",
        "value": 85.0,
        "send_data": false,
        "activation_delay": 10,
        "deactivation_delay": 3,
        "minimum_activation_duration": 30,
        "priority": 0,
        "activation_one-shot": false,
        "deactivation_action": "restore",
        "deactivation_value": null
      },
      "operations": [
        {
          "condition": {
            "id": 1,
            "type": "value",
            "port": "AI1",
            "reference": "AI3",
            "comparison": ">",
            "hysteresis": 1.0
          },
          "operator": "and"
        },
        {
          "condition": {
            "id": 2,
            "type": "value",
            "port": "AI2",
            "constant": 31,
            "comparison": "<",
            "hysteresis": 2.0
          },
          "operator": null
        }
      ]
    }
  ]
}
```

3.4.5.6.9 "Wireless"

The following menu facilitates configuring the controller to establish a Wi-Fi connection, enabling communication with a computer and allowing the use of VNC even when not connected to the local network.



- **"WiFi AP name"**: Designates the name of the device while it is being searched for connection.
- **"WPA key"**: Designates the password, if configured, to restrict access solely to users with knowledge of the password.
- **"IP address"**: Is set by default to 10.255.255.1.

3.4.5.6.10 "Display"

This menu provides options for adjusting the display brightness and setting a timer for automatic shutdown.



"Brightness": The brightness button allows the user to customize the brightness level between 1% to 100%.



"Shutdown": The shutdown button enables the user to set a specific duration after which the display will automatically shut down, helping to conserve power and enhance energy efficiency. If the timer is set to 0, then the display will always stay on. Otherwise, if the timer is set to a specific time, then the display will turn off after the specified number of minutes.

3.4.5.6.11 "Security"

In the security page it is possible to protect the device with a password, restricting access to only those who know the password. The password protects the access to settings (long click down) and the access to the valve configuration (long click up).

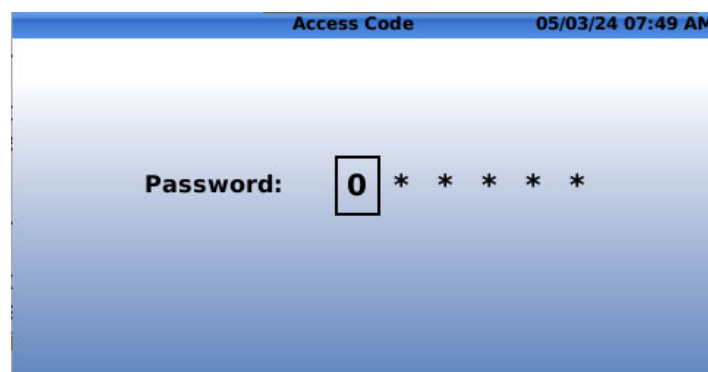

The password takes effect after performing a reboot. The device remains unlocked after entering the password. The password reactivates after 20 minutes of inactivity.

3.4.5.6.12 "Reboot"

Use this button  to reboot the electronic controller whenever necessary. Once the system reboots, it will take approximately 45 to 120 seconds to restart.

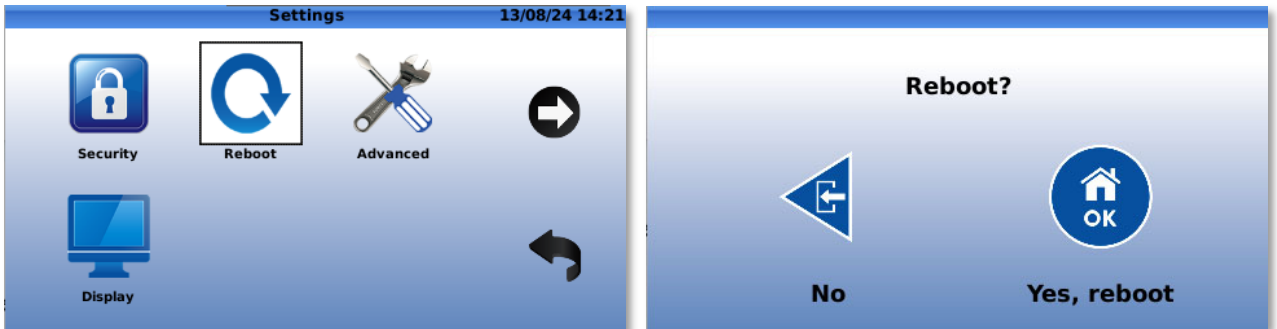

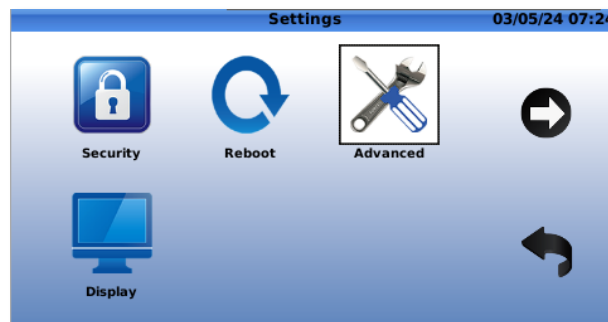

3.4.5.6.13 "Advanced" Settings Page

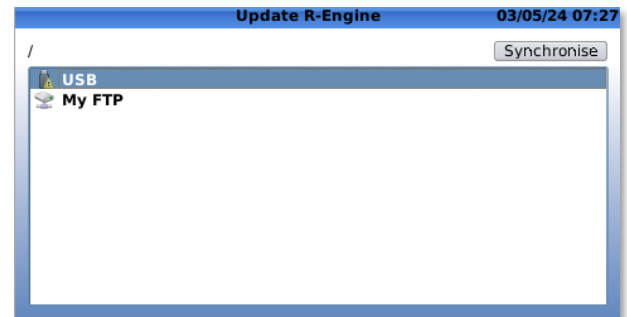
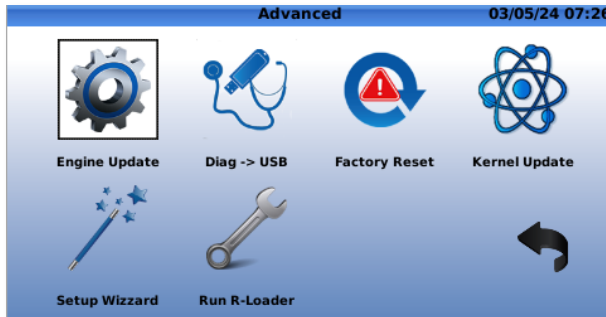

3.4.5.6.13.1 "Engine Update"



- **USB:** Click the  button to update from a USB Flash drive. If a USB Flash drive is inserted into the USB slot, then the Electronic Controller will show the contents of the drive. Navigate to the selected *.tar file and click .
- **My FTP:** If a server has been setup for connectivity, the update can be made from that server. Navigate to the selected *.tar file and click .

The Engine needs to be located on the FTP server configured in the Electronic Controller in the "SYNCDOWN" folder

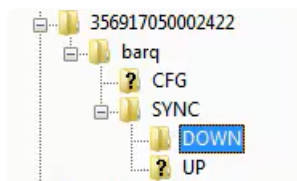

: An R-Engine update requires a *.tar file.

3.4.5.6.13.2 "Diag -> USB"

This allows to export the diagnostic file of the electronic controller. The diagnostic file cannot be used directly by the user, and is usually requested by CLA-VAL for support purposes.

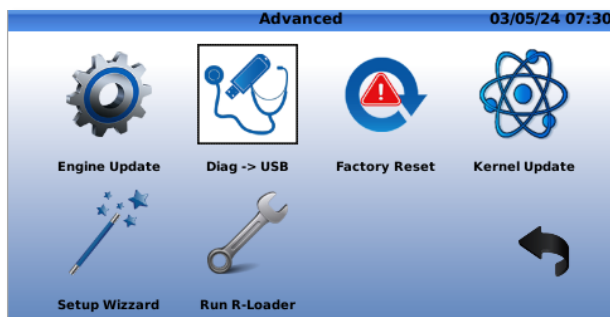

- **USB:** Click the  button to export the diagnostic file to a USB Flash drive.
- **My FTP:** If a server has been setup for connectivity, the file can be exported to that server.

While navigating, click on the  to come back to the precedent level.

3.4.5.6.13.3 "Factory Reset"

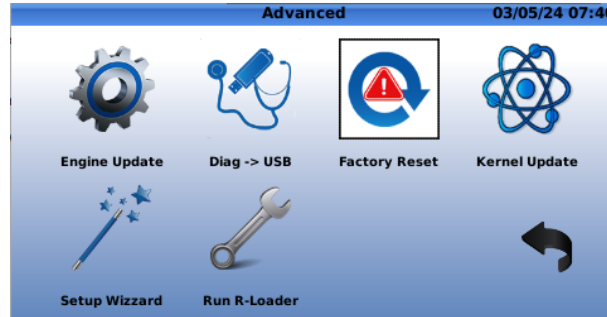

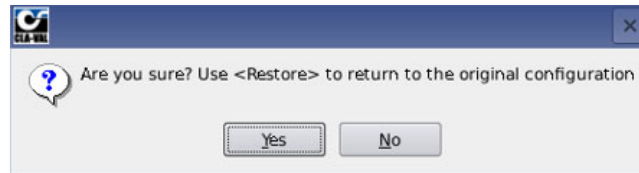

When clicking on the  icon, the following dialog box will appear to confirm or cancel the factory reset:

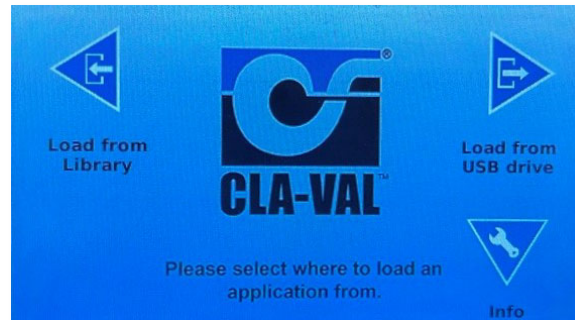

- After a factory reset, the following screen will appear to prompt the next choice:



- Click the  button to load a **ValvApps™** from the internal library. Once inside the library, select and load the desired **ValvApps™**.
- Click the  button to load a **ValvApps™** from an attached USB Flash Drive. Select and load the desired **ValvApps™**.

The electronic controller will restart, and the application will be loaded upon startup of the system.

3.5 IN-MENU "NAVIGATION"

3.5.1 KEYBOARD FUNCTIONALITY

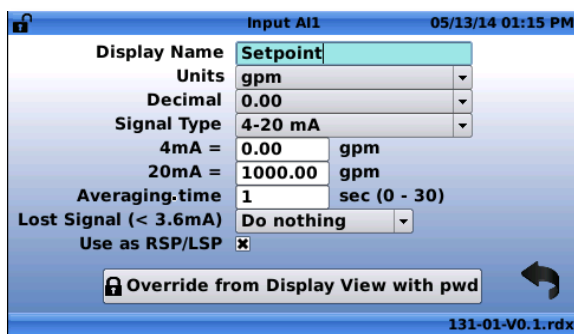

- Letter Selection - use arrow keys to navigate to letters and then press to select each letter.
- Deleting text - navigate to button and press to delete letters.
- Capital Letter (CAPS) Selection - select and press . The CAPS button will become red - . Now all of the text in the window will come in *ALL CAPITAL LETTERS*.
- Accept text - navigate to the button and press to accept the text. Alternately, long hold (more than 2 seconds) on will also accept the text.
- Cancel text changes - navigate to button and press to cancel text changes.

3.5.2 NUMERAL SELECTION

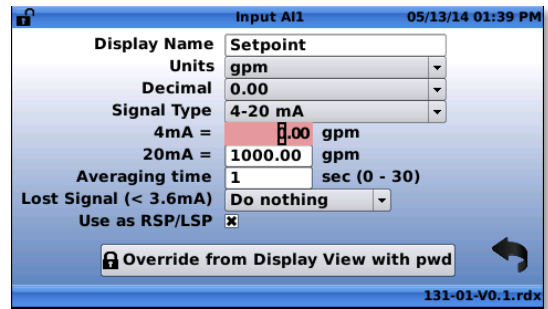
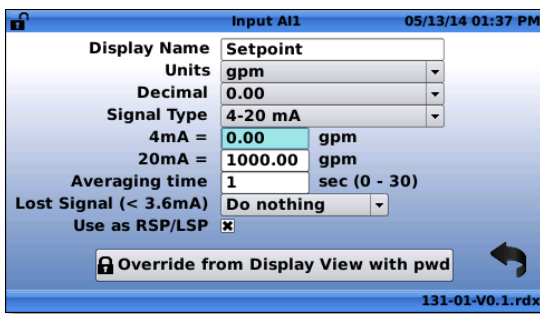

- Press to enter the numeral selection field.
- Use and to increase and decrease the selected numeral.



- Use and to move the cursor to the left and right, respectively.



- To add digits to the left of the current maximum use the to move the cursor to the left.

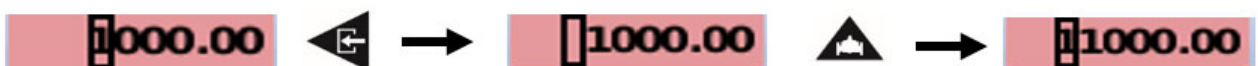

- To accept changes, select to return to exit field.

3.5.3 DROP-DOWN MENU

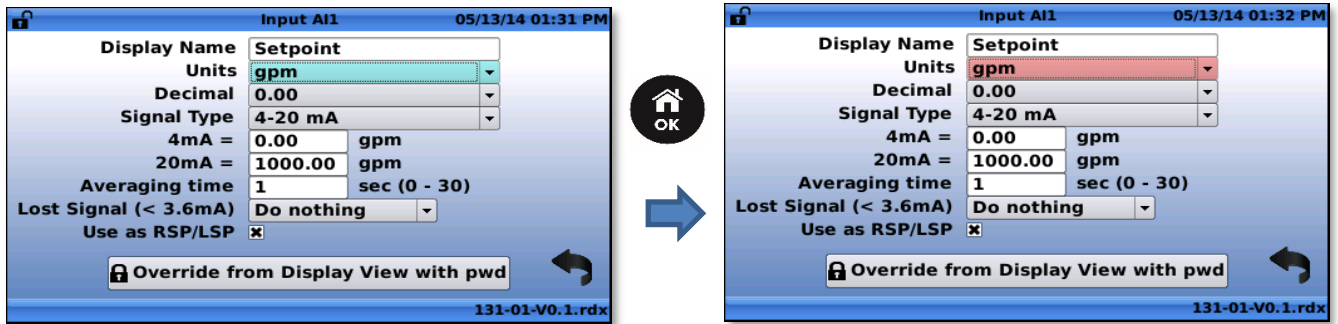

- Use and to navigate up and down the options in the drop-down menu.



- Short click to accept the selection.
- Long click will escape to Home Screen and cancel any selections.

4 SPECIFIC FEATURES

4.1 ADD INPUTS MANUALLY

It is possible to add inputs even if they are not initially introduced to **ValvApps™**. This is advantageous when additional sensors need to be added.

To manually add an input, perform a long click-left, then click on the button "+" as shown in the following figure, and select the desired input. Finally, click "OK". The input will then appear on the list of inputs.

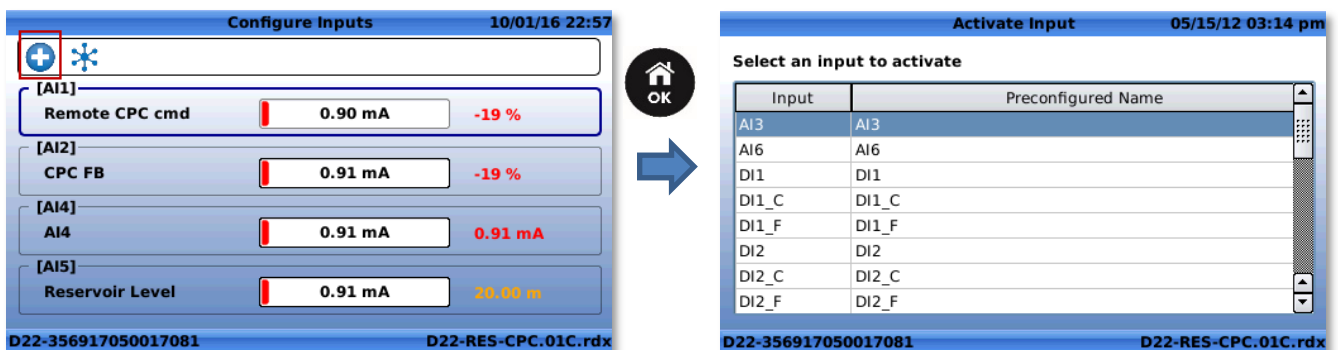

To display an input on the home screen, perform a long-left click, then in the list of inputs, click on the desired input and check the box as shown in the following figure. To remove a manually added input, click on the red trash icon.

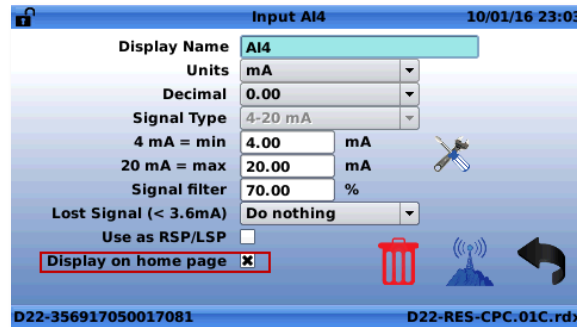

4.2 CUSTOM SCALING

This feature is useful to re-scale signals of 4-20 mA sensors when the practical application range is reduced (say for instance 6-16 mA).

To custom scale an input, go to the "Configure Inputs" screen:

Long click left > Left on input to be custom scaled.

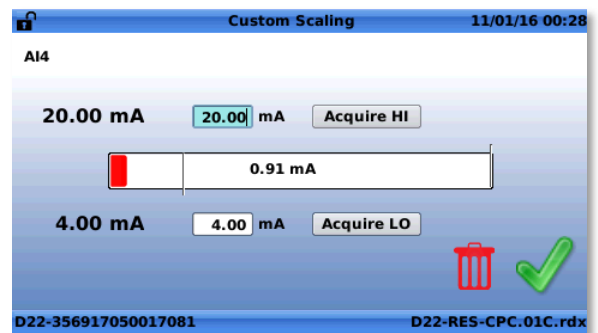
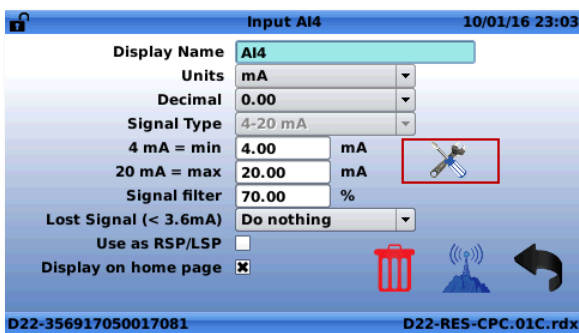

Push "Acquire Lo" to set the minimum value and "Acquire Hi" to set the maximum value and validate it with the . Note that the sensor can also have a reversed range, i.e. minimum physical value for 20 mA and maximum physical value for 4 mA.

4.3 E-LIFT AUTOCALIBRATION

The Autocalibration feature for e-Lift enables the use of full-range sensors and streamlines the calibration process for precise and efficient operation.

To initiate the autocalibration procedure, from the home screen, perform a long press on the left button. Select the input channel to which the e-Lift is connected, then enter the configuration menu by pressing left again and then click on the tools icon.

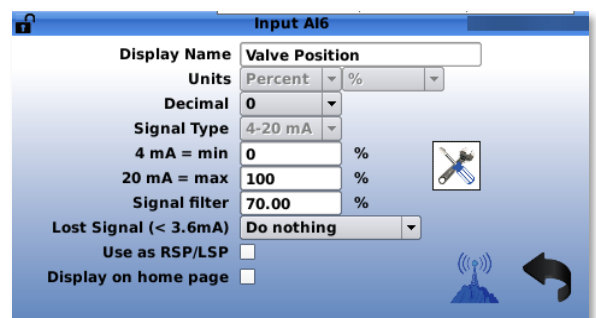
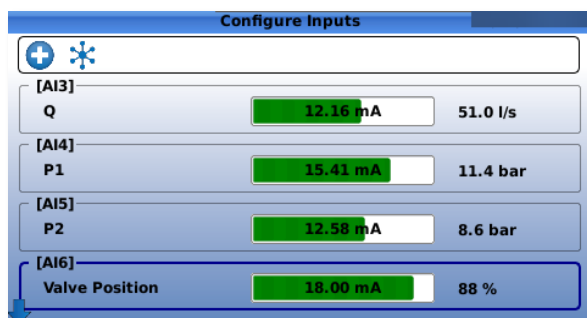

Navigate to the **"Autocalibrate"** tab and input the relevant valve specifications. Select the appropriate sensor type based on the valve dimensions: for valves up to DN 200, select 32-200; for valves up to DN 400, select 250-400; for valves up to DN 600, select Tytan; and for valves greater than DN 600, select e-Lift-34 for Tytan. Ensure the valve is fully closed, then initiate the calibration process by clicking the **"Autocalibrate"** button.

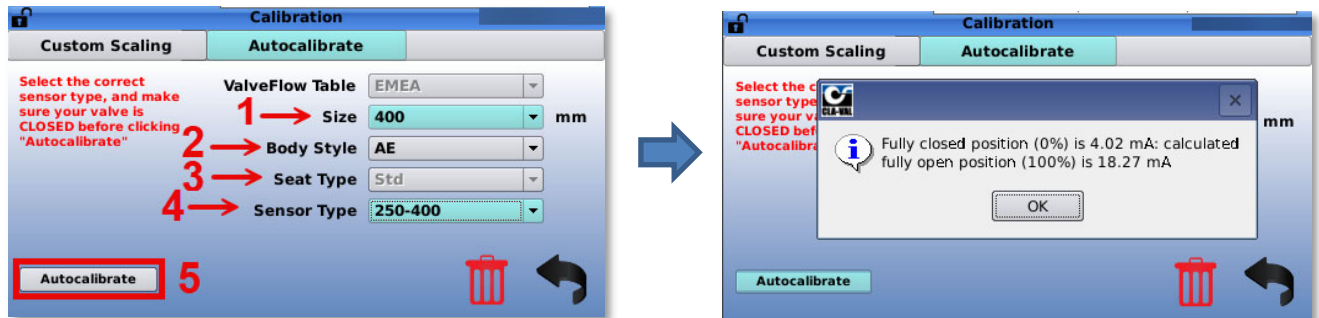

4.4 INPUT FILTERING

Signal filtering can be implemented for the analogue inputs of the electronic controller to reduce the noise coming from the sensors and stabilize the signal. The filter can be adjusted in the **"Configure Inputs"** screen:

Long click left > Left on the selected input.

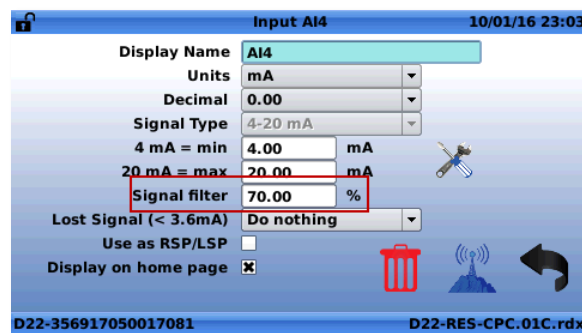

The value can be set from 1% (light) to 99% (strong) or disabled. The default value is set at 70%, which is usually a good filtering for most of the application.

This default value of 70% should not be changed, unless required!

4.5 REMOTE CONFIGURATION

Remote editing and modification of control curves, set-points, and variables are possible through the CLA-VAL Link2Valves web platform. This capability proves invaluable when adjustments to the operational mode or regulation profile characteristics are required, eliminating the need to dispatch a technician to the field. For example, transitioning from fixed pressure regulation to automatic pressure vs. flow regulation profile, or gradually adjusting the PRV outlet pressure set point until reaching the network's optimal point, are all achievable remotely.

To use this functionality, the electronic controller needs to be connected to the internet (either via the cellular network or via Ethernet) and registered in the CLA-VAL **Link2Valves** platform for a user with Administrator rights (contact CLA-VAL for more details).

4.5.1 REGISTER THE ELECTRONIC CONTROLLER ON LINK2VALVES

Long click down > "Connectivity" > "Cloud Storage"

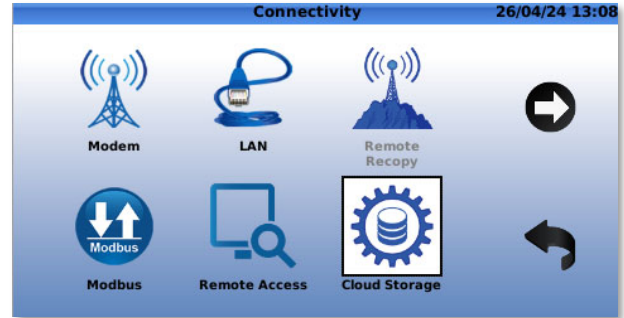
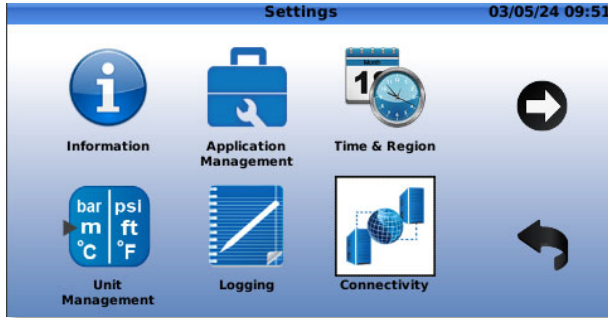

1. Enter "Cla-Val Link2Valves" in "Setup".
2. Enter the e-mail address in "Registration e-mail".
3. Click on "Register" and wait for process to complete.

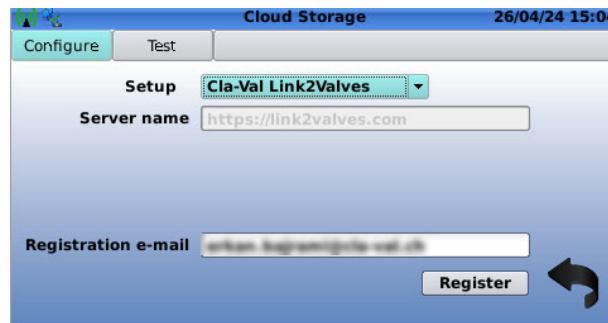

4.5.2 CONNECT TO LINK2VALVES

If already registered in *Link2Valves*, connect to www.link2valves.com and log in.

If not registered, click on the automatic email received from *no-reply@link2valves.com* (check your spam box if not in your inbox) and enter a password in the website. Ask CLA-VAL to get administrator rights.



See the Link2Valves User Guide for more details on how to use the functionality of Link2Valves.

4.6 HTTPS PEERING VIA L2V

The HTTPS Peering feature allows the connection of two or more D22 devices to communicate and exchange information with each other. This functionality is particularly useful in scenarios where measurements are taken far from the valve, such as when the tank is located at a distance. In such cases, the D22 placed near the tank measures the level, and then sends this value to the D22 controlling the valve. Based on these values, the controller will activate the actuator to achieve the desired setpoint.

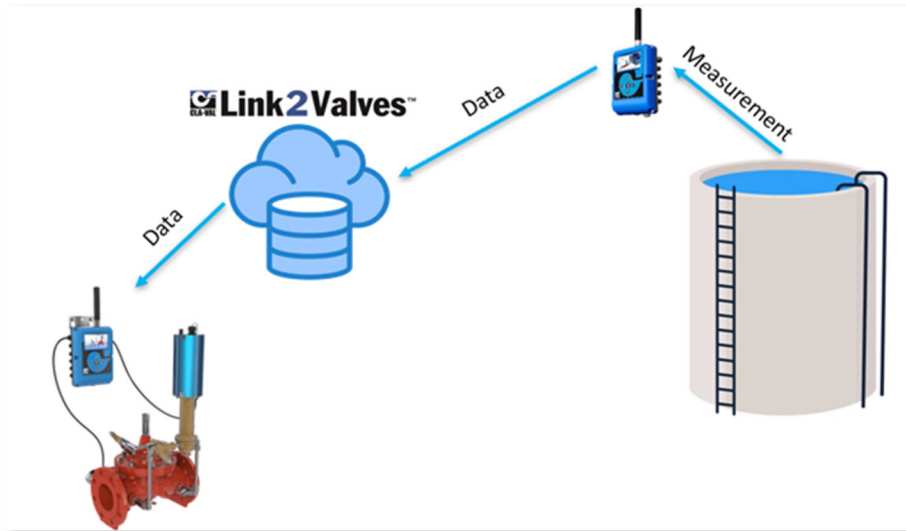

To use this feature, it is necessary for the devices intended to communicate to be connected through the Link2Valves. The first step is to configure the Peering feature on L2V. To do this:"

1. From the main page of Link2Valves, click on the **"Peering"** section.

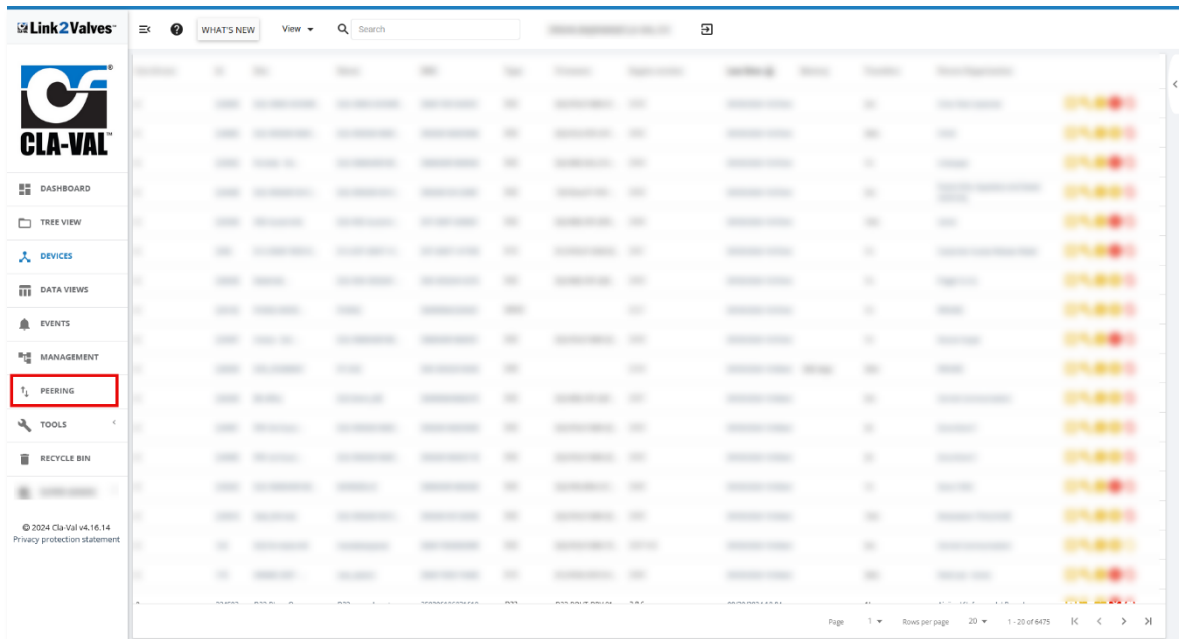

2. Click on **"Add a Subscription"** to create a new communication link between two devices.
3. Select the device that will publish the data and the device that will receive the data.
4. Choose the inputs you want to transmit to the other device. For the publisher, it is also possible to publish its outputs.
5. Finally click on the button **"Add Subscription"**.

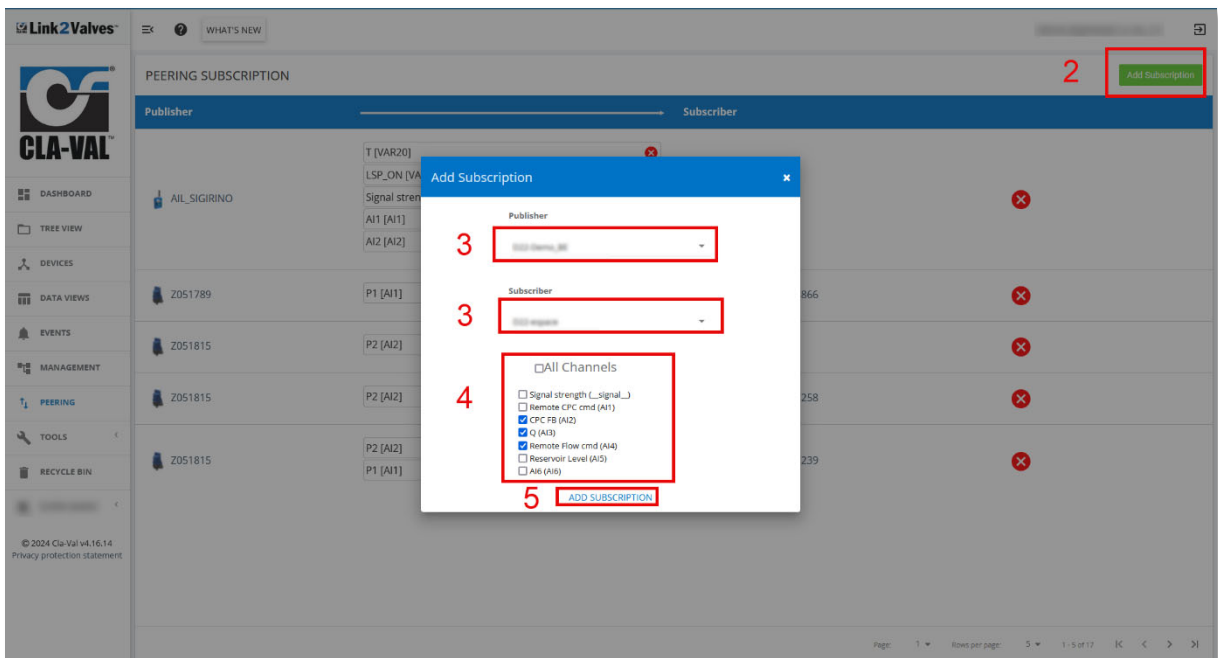

After configuring the HTTPS Peering on Link2Valves, the next step is to configure the D22s to communicate between them.

To configure the Peering feature on the D22, follow these steps:

1. From the Home Screen, perform a long click down to access to the settings of the D22.
2. Enter the **Connectivity** menu and navigate to the **Remote Recopy** menu.

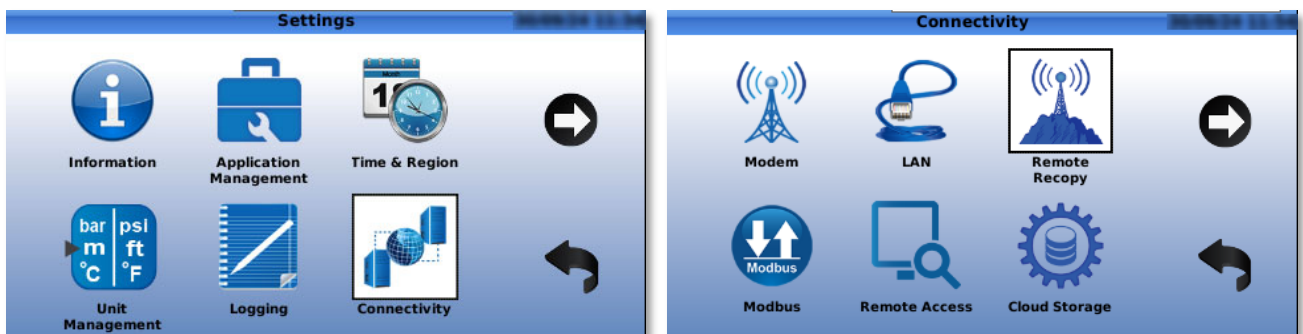

3. In the **Publisher** menu, configure the device that will publish its data. Enable publishing and choose the interval of publishing.



Please remind that higher frequency of publishing consumes more data bandwidth.

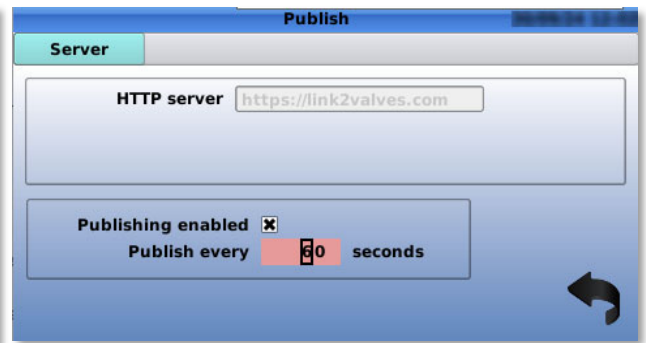
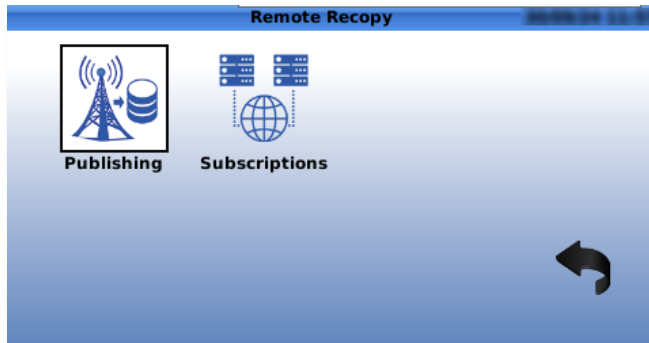

4. In the **Subscriber** menu, configure the device that will receive the data.
 - a. Click on the following button to search for publishers, then click and enter on the publisher menu from which the data will be subscribed.

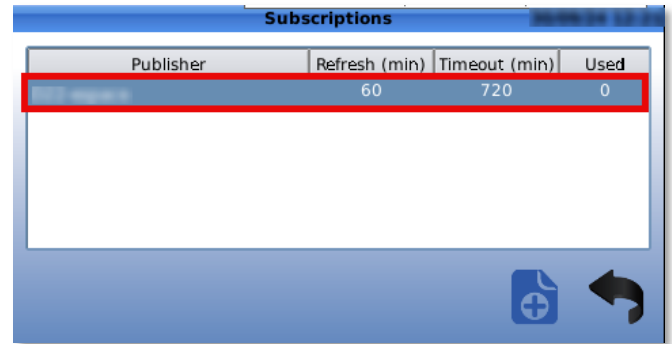

- b. After selecting the publisher, choose the data refresh interval and set the timeout duration in case no data is available.



- c. Click on the **"Channel Use"** tab and then click on the button to add the channels you want to subscribe to.

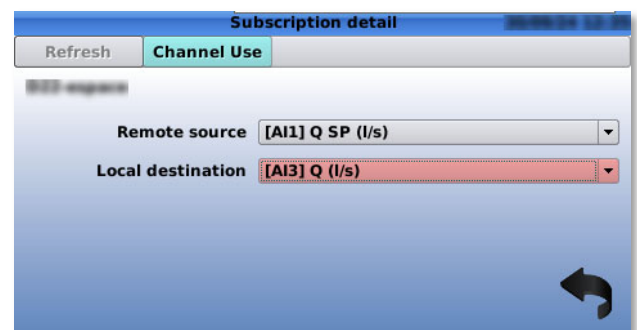
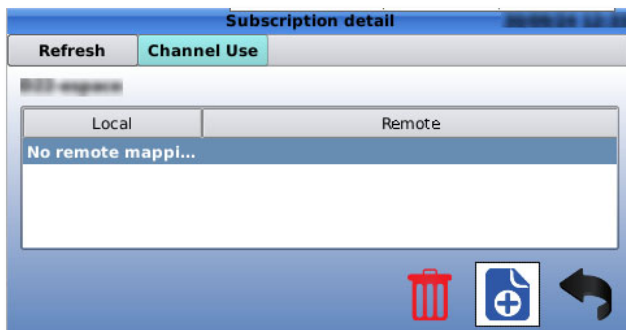

By completing these steps, the D22 devices will be able to communicate effectively via the HTTPS Peering.

5.2.4 HOLDING REGISTERS

Function Code 03 - Read Holding Register: It is designed for reading data from the holding registers.

Function Code 06 - Write Single Register: It is used for writing in a single register.

Function Code 16 - Write Multiple Registers: It is designed for writing multiple registers.

The three function codes above can be used on holding registers, the holding registers span the address range from 40000 to 43999. Below it will be explained separately according to the information and the data type of the holding registers.

In the table below, details regarding the holding registers between addresses 40000 and 40999 are displayed. The first 19 addresses are used. Each address stores 1 byte of data.

Function code	Address	Data Property	Data Type	I/O	Information	Bit maps															
						0	1	2	3	4	5	6	7	8	9	10	11	12	13	14	15
Holding Registers 03: Read Holding Registers 06: Write Single Registers 16: Write Multiple Registers	40000	Read-Only	Word	Multi	Analog Input Out of Range Status	AI1	AI2	AI3	AI4	AI5	AI6	-	-	-	-	-	-	-	-		
	40001	Read-Only	Word	Multi	Digital Counter Input Out of Range Status	DI1_C	DI2_C	DI3_C	DI4_C	DI5_C	DI6_C	-	-	-	-	-	-	-	-		
	40002	Read-Only	Word	Multi	Digital Frequency Input Out of Range Status	DI1_F	DI2_F	DI3_F	DI4_F	DI5_F	DI6_F	-	-	-	-	-	-	-	-		
	40003	Read-Only	Word	Multi	Analog Input Local Override Status	AI1	AI2	AI3	AI4	AI5	AI6	-	-	-	-	-	-	-	-		
	40004	Read-Only	Word	Multi	Digital Input Local Override Status	DI1	DI2	DI3	DI4	DI5	DI6	-	-	-	-	-	-	-	-		
	40005	Read-Only	Word	Multi	Digital Counter Input Local Override Status	DI1_C	DI2_C	DI3_C	DI4_C	DI5_C	DI6_C	-	-	-	-	-	-	-	-		
	40006	Read-Only	Word	Multi	Digital Frequency Input Local Override Status	DI1_F	DI2_F	DI3_F	DI4_F	DI5_F	DI6_F	-	-	-	-	-	-	-	-		
	40007	Read-Write	Word	Multi	Analog Input Modbus Override Active Bit	AI1	AI2	AI3	AI4	AI5	AI6	-	-	-	-	-	-	-	-		
	40008	Read-Write	Word	Multi	Digital Input Modbus Override Active Bit	DI1	DI2	DI3	DI4	DI5	DI6	-	-	-	-	-	-	-	-		
	40009	Read-Write	Word	Multi	Digital Counter Input Modbus Override Active Bit	DI1_C	DI2_C	DI3_C	DI4_C	DI5_C	DI6_C	-	-	-	-	-	-	-	-		
	40010	Read-Write	Word	Multi	Digital Frequency Input Modbus Override Active Bit	DI1_F	DI2_F	DI3_F	DI4_F	DI5_F	DI6_F	-	-	-	-	-	-	-	-		
	40011	Read-Only	Word	Multi	Analog Output Local Override Status	AO1	AO2	AO3	AO4	-	-	-	-	-	-	-	-	-	-		
	40012	Read-Only	Word	Multi	Digital Output Local Override Status	SO1	SO2	RO1	RO2	-	-	-	-	-	-	-	-	-	-		
	40013	Read-Only	Word	Multi	Analog Output Alarm Active Status	AO1	AO2	AO3	AO4	-	-	-	-	-	-	-	-	-	-		
	40014	Read-Only	Word	Multi	Digital Output Alarm Active Status	SO1	SO2	RO1	RO2	-	-	-	-	-	-	-	-	-	-		
	40015	Read-Only	Word	Multi	Analog Output Recopy Active Status	AO1	AO2	AO3	AO4	-	-	-	-	-	-	-	-	-	-		
	40016	Read-Only	Word	Multi	Digital Output Recopy Active Status	SO1	SO2	RO1	RO2	-	-	-	-	-	-	-	-	-	-		
	40017	Read-Write	Word	Multi	Analog Output Modbus override active bit	AO1	AO2	AO3	AO4	-	-	-	-	-	-	-	-	-	-		
	40018	Read-Write	Word	Multi	Digital Output Modbus override active bit	SO1	SO2	RO1	RO2	-	-	-	-	-	-	-	-	-	-		
40019 - 40999	Read-Only				Not used	-	-	-	-	-	-	-	-	-	-	-	-	-			

The Holding Registers mapped between addresses 40000 to 40002 are Read-Only registers and contain information about the range status of the analog and digital inputs. They are used to check if any of the input values are out of range.

The Holding Registers between 40003 to 40006 are Read-Only registers and contain information about the override status of the analog and digital inputs. Are used to check if any input is being overridden.

The Holding Registers between 40007 to 40010 are Read-Write registers which contain information about the active bit.

Note: "To enable the override on an input/output, it is essential to set the correct value for the active bit".

To enable forcing on the analog inputs AIx, the value of Holding Register 40007 must be set to one of the specific values corresponding to the input that needs to be forced:

- Enable forcing for AI1 then the value of the HR 40007 must be set on 1
- Enable forcing for AI2 then the value of the HR 40007 must be set on 2
- Enable forcing for AI3 then the value of the HR 40007 must be set on 4
- Enable forcing for AI4 then the value of the HR 40007 must be set on 8
- Enable forcing for AI5 then the value of the HR 40007 must be set on 16
- Enable forcing for AI6 then the value of the HR 40007 must be set on 32

To disable any override the value of the HR 40007 must be set on 0

To enable the override on multiple inputs simultaneously, the value of HR 40007 must be equal to the sum of the digits used to activate forcing on a single input. For example:

- AI1 & AI2 then the value of the HR 40007 must be set on 3
- AI3 & AI5 then the value of the HR 40007 must be set on 20
- AI5 & AI6 then the value of the HR 40007 must be set on 48 ect.

The same logic is followed to enable the forcing on other analog and digital input/outputs.

Note: that an override will have no effect if:

- The write operation is incomplete (Typically Enable forcing is off).
- The supplied value is out of the permitted range.
- A local override, an alarm, or a recopy is active.

Function code	Address	Data Property	Data Type	I/O	Information	Bit maps																
						0	1	2	3	4	5	6	7	8	9	10	11	12	13	14	15	
Holding Registers	03: Read Holding Registers 06: Write Single Registers 16: Write Multiple Registers	42000	Read-Write	IEEE Float	AI1	Logical Analog Inputs Value	high-order word															
		42001					low-order word															
		42002	Read-Write	IEEE Float	AI2		high-order word															
		42003					low-order word															
		42004	Read-Write	IEEE Float	AI3		high-order word															
		42005					low-order word															
		42006	Read-Write	IEEE Float	AI4		high-order word															
		42007					low-order word															
		42008	Read-Write	IEEE Float	AI5		high-order word															
		42009					low-order word															
		42010	Read-Write	IEEE Float	AI6		high-order word															
		42011					low-order word															
		42012	Read-Write	IEEE Float	DI1_C	Logical Digital Counter Inputs Value	high-order word															
		42013					low-order word															
		42014	Read-Write	IEEE Float	DI2_C		high-order word															
		42015					low-order word															
		42016	Read-Write	IEEE Float	DI3_C		high-order word															
		42017					low-order word															
		42018	Read-Write	IEEE Float	DI4_C		high-order word															
		42019					low-order word															
		42020	Read-Write	IEEE Float	DI5_C		high-order word															
		42021					low-order word															
		42022	Read-Write	IEEE Float	DI6_C		high-order word															
		42023					low-order word															
		42024	Read-Write	IEEE Float	DI1_F	Logical Digital Frequency Inputs Value	high-order word															
		42025					low-order word															
		42026	Read-Write	IEEE Float	DI2_F		high-order word															
		42027					low-order word															
		42028	Read-Write	IEEE Float	DI3_F		high-order word															
		42029					low-order word															
		42030	Read-Write	IEEE Float	DI4_F		high-order word															
		42031					low-order word															
		42032	Read-Write	IEEE Float	DI5_F		high-order word															
		42033					low-order word															
		42034	Read-Write	IEEE Float	DI6_F		high-order word															
		42035					low-order word															
		42036	Read-Write	IEEE Float	AO1	Logical Analog Outputs Value	high-order word															
		42037					low-order word															
		42038	Read-Write	IEEE Float	AO2		high-order word															
		42039					low-order word															
		42040	Read-Write	IEEE Float	AO3		high-order word															
		42041					low-order word															
		42042	Read-Write	IEEE Float	AO4	high-order word																
		42043				low-order word																
		42044	Read-Write	IEEE Float	SO1	Logical Output Value (PWM value 0-100%)	high-order word															
		42045					low-order word															
		42046	Read-Write	IEEE Float	SO2		high-order word															
		42047					low-order word															
		42048	Read-Write	IEEE Float	RO1		high-order word															
		42049					low-order word															
		42050	Read-Write	IEEE Float	RO2		high-order word															
		42051					low-order word															
		42052	Read-Only	IEEE Float	Vbatt		Battery level	high-order word														
42053					low-order word																	
42054 - 42499	Read-Only			Not used	-																	

The table below details the registers located at addresses 43000 to 43499. The only difference between this table and the previous one lies in the type of data. The holding registers of this table contain integer data, whereas in the previous one they contained floating-point data.

	Function code	Address	Data Property	Data Type	I/O	Information	Bit maps															
							0	1	2	3	4	5	6	7	8	9	10	11	12	13	14	15
Holding Register	03: Read Holding Registers 06: Write Single Registers 16: Write Multiple Registers	42500	Read-Write	IEEE Float	VAR 1	Internal Variable	high-order word															
		42501					low-order word															
		42502	Read-Write	IEEE Float	VAR 2		high-order word															
		42503					low-order word															
		...	Read-Write	IEEE Float	...		high-order word															
		...					low-order word															
		42998	Read-Write	IEEE Float	VAR N		high-order word															
		42999					low-order word															
		43500	Read-Write	INT 32	VAR 1		high-order word															
		43501					low-order word															
		43502	Read-Write	INT 32	VAR 2		high-order word															
		43503					low-order word															
		...	Read-Write	INT 32	...		high-order word															
		...					low-order word															
		43998	Read-Write	INT 32	VAR N		high-order word															
		43999					low-order word															

The full mapping schema version 10 can be downloaded on CLA-VAL Europe web site: www.cla-val.ch

6 APPENDIX: MODBUS INTERFACE FOR VARIOUS SLAVE SENSORS

6.1 CLA-VAL e-DRIVE-34 ACTUATOR

The e-Drive-34 actuator is fully interfaced to the electronic valve controller via its Modbus RS-485 interface, connected to the e-Drive-34 Souriau circular connector.

 **IMPORTANT: this feature requires the e-Drive-34 actuator to be loaded with firmware version 4.03 or higher!**

6.1.1 INTERFACING AN e-DRIVE-34 ACTUATOR TO THE ELECTRONIC VALVE CONTROLLER

1. Turn off the electronic valve controller.
2. Connect the circular plug cable on the e-Drive-34 and the electronic valve controller.
 - a. According to this wiring table.

Circular plug cable	Designation	D22	e-Drive-34
1	24V	V+	A
2	0V	V-	B
3	GND	RS-485 GND	C
4	485A	RS-485 485A	D
5	485B	RS-485 485B	E
6	Libre	-	F

3. Turn on the electronic valve controller.
4. Go into "**Settings**" (long click down) > "**Connectivity**" > "**Modbus**".

5. In the "RS-485" tab.
 - a. Enable the checkbox to allow **Modbus RS-485** connection.
 - b. Set "**Line Speed**" at "**9600**" baud.
 - c. Set "**IEEE float word order**" to "**MSW:LSW**".
 - d. Check the checkbox to "**Run as Modbus master**".

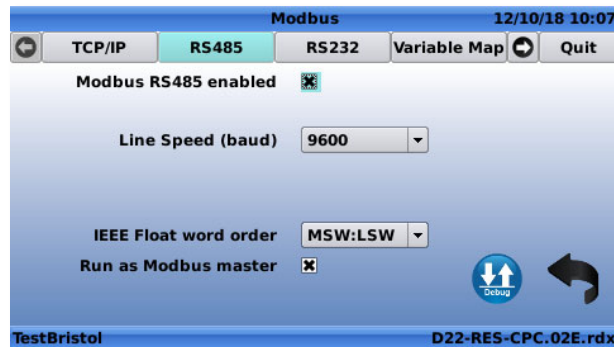

6. In the "**Devices**" tab (right click to reach the tab).
 - a. Click on the "+" button.



7. Create the Modbus device.
 - a. Set "**Device type**" to "**eDrive34**".
 - b. "**Device ID**" to the slave address of the e-Drive-34 (default: 1).
 - c. Give a name to the device.
 - d. Set the "**Poll interval**" (default: 1 second).
 - e. Click on "✓" to add/create the device.

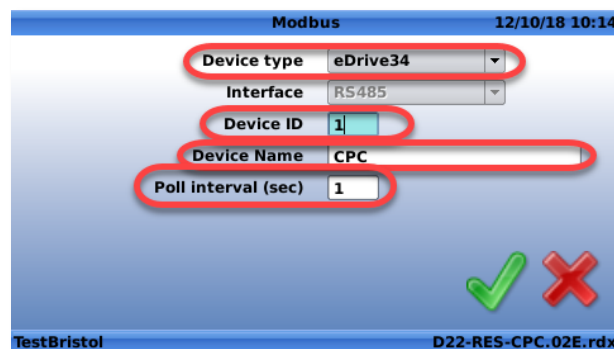

f. The e-Drive-34 is created and now controllable via Modbus.



Once the actuator is interfaced to the electronic valve controller advanced controller, the following e-Drive-34 signals are available:

- Inputs:
 - `<name_of_device>.FB` -> Feedback
 - `<name_of_device>.HighAlarm` -> HighAlarm
 - `<name_of_device>.LowAlarm` -> LowAlarm
- Output:
 - `<name_of_device>.Cmd` -> Command

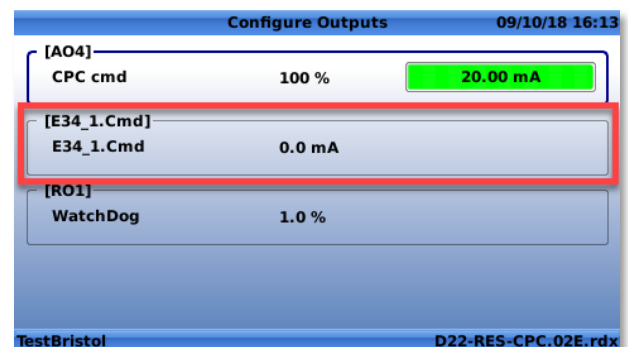
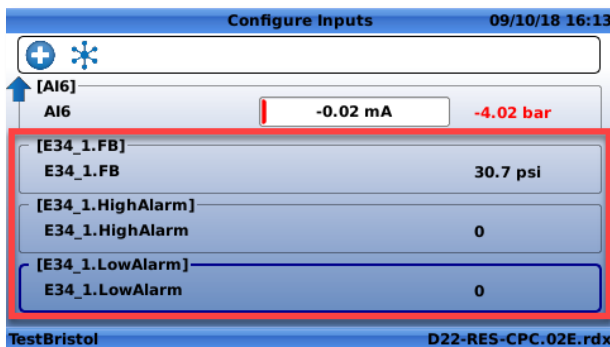

All the inputs/outputs can be used into followings electronic valve controller regulation blocks:

- PID
- Control Curve
- Input recopy
- Signal retransmission
- Actions

6.1.2 CALIBRATE AN e-DRIVE-34 ACTUATOR FROM THE ELECTRONIC VALVE CONTROLLER

It is also possible to calibrate the e-Drive-34 with a D22 controller (via its Modbus RS-485 interface), preventing the need of a computer in the field. The electronic valve controller graphical interface replicates the e-Drive-34 PC software information/commands, with an improved user experience (context-sensitive assistance). To navigate to the e-Drive-34 user interface:

(Long click up) "Configuration" > "eDrive34".

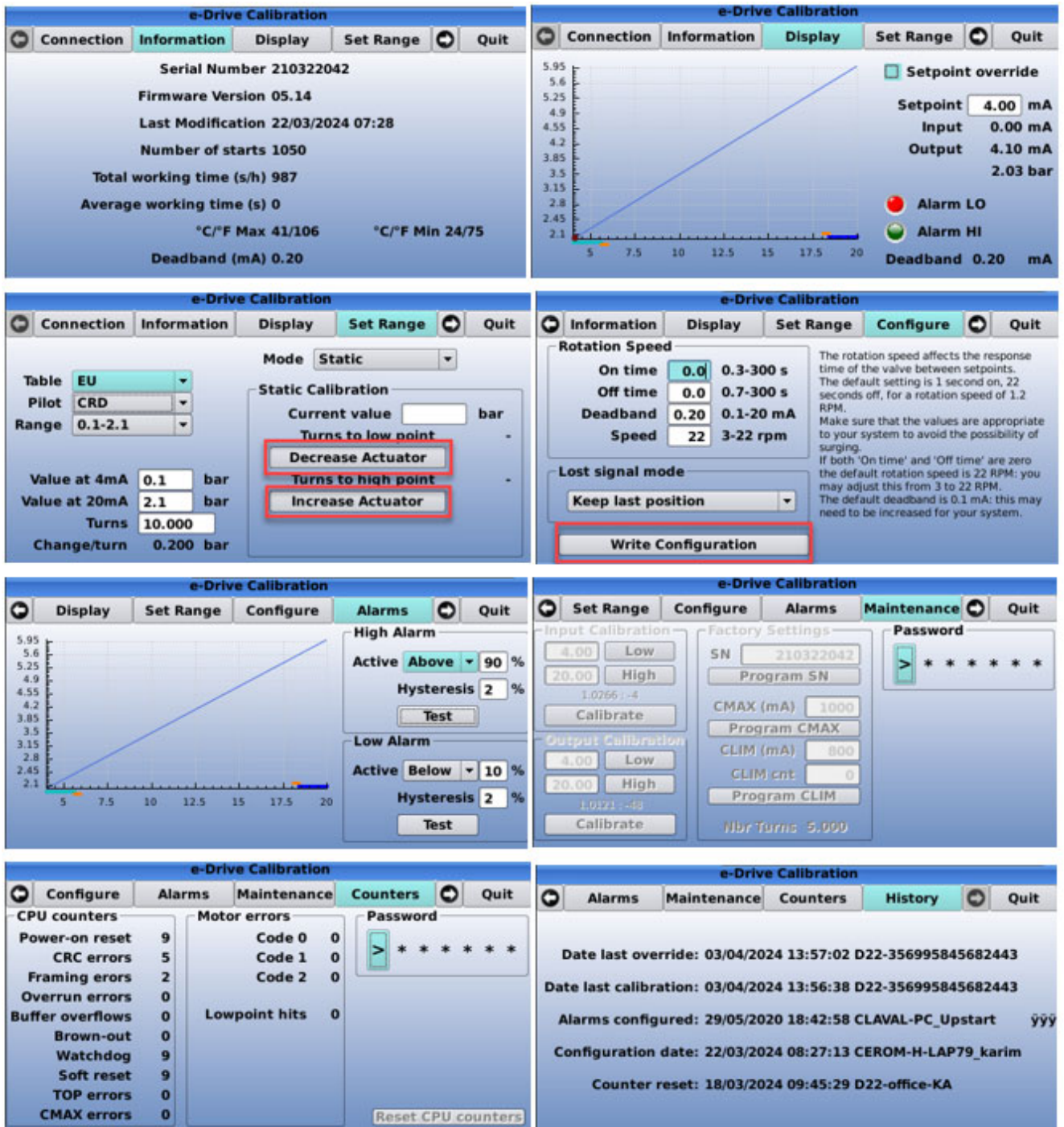

How to access the menu:

Once the e-Drive-34 is interfaced (see chapter 6.1.1), click on the "eDrive34" icon into "Configuration" menu (Long click up).

1. By default, the "Modbus slave address" of an e-Drive-34 actuator is set to 1.
2. It is possible to connect up to five e-Drive-34 to an electronic valve controller, by setting a different Modbus slave address for each actuator, before connecting them at the same time.
3. When changing settings, the button "Write calibration" appears. Click on this button to save changes.
4. The "Maintenance" tab is protected by password, providing access only to advanced users, and avoiding unwanted misuse. Please contact your CLA-VAL representative if the password is requested.

6.2 SENSOR INTERFACE DEFINITION FILE

The sensor interface definition file is used to describe a sensor and its values. The file contains a description for the values available from the sensor (Modbus address, unit, range of the value, etc.). This chapter explains how to create a description file for a specific sensor.

All the values described in the sensor interface definition file can be used into the following electronic valve controller regulation blocks:

- PID
- Control Curve
- Input recopy
- Signal retransmission
- Actions

The sensor interface definition file (.def) is composed of the following section:

1. .ID This section defines a sensor type.
2. .Channels This section defines the channels provided by the sensor.
3. .ReadRequest X This section(s) defines Modbus read request(s). X is the id of the request.
4. .WriteRequest X This section(s) defines Modbus write request(s).

This is an example of the definition file (edrive34.def) for the CLA-VAL e-Drive-34:

```
# EDrive34 difinition file
.ID
Equipment=eDrive34,E34,rs485
.Channels
Cmd=2
FB=0,4,0,0,100
LowAlarm=1
HighAlarm=1
.ReadRequest 1
registers=4,23,5
Cmd=0,int16,moto,raw,40,200
FB=2,int16,moto,raw,40,200
LowAlarm=3,int16,moto,cooked
HighAlarm=4,int16,moto,cooked
.WriteRequest 1
registers=16,23,2
Cmd=0,int16,moto,raw,40,200
```



: The "#" character is used to add comment into the file.



: No empty line are accepted in the .def file.

6.2.1 ".ID" SECTION

This .ID section defines the sensor type. The section contains only one line beginning with "Equipment", followed by the sensor type name, the base name, and the interface to use.

```
Equipment=<equipment type name>,<base name>,<interface>
```

- <equipment type name> is informational
- <base name> indicates the base name affected to object and channels
- <interface> = rs485/tcpip/both



: tcpip & both are not yet implemented in version 2.3.1

6.2.2 ".CHANNELS" SECTION

This .Channels section defines the channels of the sensor. The section contains one line for each channel beginning with the channel base name, followed by the channel type, unit type, unit code, minimum value, and maximum value.

```
<channel name>=<type>,<unittype>,<unitcode>,<min>,<max>
```

- <type> = Code of the channel type
- <unittype> = Code of the unit type (optional)
- <unitcode> = Code of the unit (optional)
- <min> = Minimum acceptable value, natural units (optional)
- <max> = Maximum acceptable value, natural units (optional)

The following tables describe the various codes:

Channel Type	Code
Analog Input	0
Digital Input	1
Analog Output	2
Digital Output	3

Unit Type	Unit Type Code	Unit	Unit Code
Analog	0	mA	0
Analog	0	V	1
Flow	1	gpm	0
Flow	1	mgd	1
Flow	1	cfm	2
Flow	1	cfs	3
Flow	1	l/m	4
Flow	1	l/s	5
Flow	1	m3/h	6
Flow	1	MI/d	7
Flow	1	UK gpm	8
Pressure	2	bar	0
Pressure	2	kPa	1
Pressure	2	Mhd	2
Pressure	2	psi	3
Height	3	m	0
Height	3	in	1
Height	3	ft	2
Height	3	%	3

Unit Type	Unit Type Code	Unit	Unit Code
Percent	4		
Time	5		
Volume	6	g	0
Volume	6	mg	1
Volume	6	cf	2
Volume	6	l	3
Volume	6	m3	4
Volume	6	MI	5
Volume	6	UK g	6
No Unit	7		
PH	8	PH	0
Free Rad	9	Cl	0
Temperature	10	deg C	0
Temperature	10	deg F	1
Turbidity	11	FNU	0
Turbidity	11	NTU	1
Turbidity	11	FAU	2

6.2.3 ".READREQUEST" SECTION

This ".ReadRequest" section defines the Modbus read request of the sensor. The section contains one line for registers to read, and one line for each channel to assign to the register(s). It is possible to have several ".ReadRequest"; e.g.: ".ReadRequest 1", ".ReadRequest 2", etc.

```
registers=<function code>,<register address>,<read count>
```

- <function code> = Modbus function code to use
- <register address> = Address of 1st register to read
- <read count> = Number of 16-bit registers to read

```
<channel name>=<offset>,<type>,<format>,<state>{[,<scale>]}|{,<min>,<max>}
```

- <offset> = Register offset in reply
- <type> = int16/int32/float
- <format> = moto/intel (applies only to int32 and float)
 - Moto: Big-endian, most significant bit/word.
 - Intel: Little-endian, least significant bit/word.
- <state> = cooked/raw
 - cooked: There is an optional scaling factor <scale>. For instance, if vbatt is provided as mV * 10, there is a scaling factor of 0.01 to get the value in volts. If not supplied, <scale> is 1
 - raw: Then min/max for the raw data values must be supplied so that the Electronic Valve Controller can calculate gain+offset to get from the raw value to the physical min/max defined for the channel

6.2.4 ".WRITEREQUEST" SECTION

This ".WriteRequest" section defines the Modbus write request of the sensor. The section contains one line for registers to read, and one line for each channel to assign it to a register. It's possible to have several ".WriteRequest"; e.g.: ".WriteRequest 1", ".WriteRequest 2", etc.

The description of a ".WriteRequest" is exactly the same than the ".ReadRequest".

6.3 ADDING SENSOR INTO THE ELECTRONIC VALVE CONTROLLER

This chapter explains how to add a custom sensor, described by a sensor interface definition file (.def), into a electronic valve controller.

1. Create a sensor interface definition file, according the process describes in chapter 6.2.
 - a. For this example we'll use a D22 like a sensor and read two values: AI1 (IN) and AO1 (OUT) as input channel type, this is the description file:

```
.ID
Equipment=D22,D22,rs485
.Channels
IN=0,4,0,0,100
OUT=0,4,0,0,100
.ReadRequest 1
registers=3,42001,2
IN=0,float,moto,cooked
.ReadRequest 2
registers=3,42201,2
OUT=0,float,moto,cooked
```

2. Save this file with the .def extension, ex: D22_test.def.
3. Copy this file into a USB key.
4. Plug the USB key into the electronic valve controller.
5. On electronic valve controller, go into **"Settings"** (long click down) > **"Connectivity"** > **"Modbus"**.

- a. On the "RS485" tab.
 - i. Check the checkbox "Modbus RS485 enabled".
 - ii. Set "Line Speed", *is mandatory to set the same value on the Modbus Master and Modbus slave.*
 - iii. Set "IEEE Float word order", MSW:LSW for D22.
 - iv. Check the checkbox "Run as Modbus master".

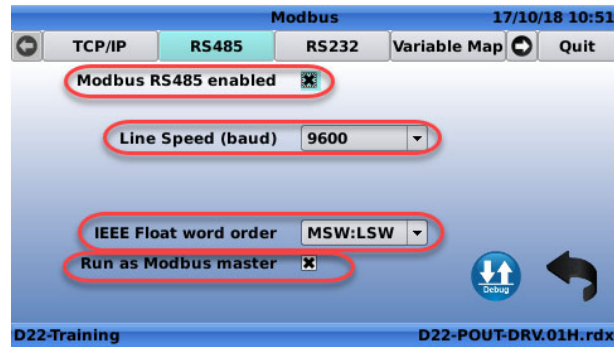

- b. On the "Devices" tab, on the far right.
 - i. Click on the button to import file.



- ii. Browser into USB key to reach the definition file and click "Ok".
- iii. Click on the "+" button to add the new sensor.



- iv. Select the "**Device type**" sensor, defined into the sensor interface definition file.
- v. Set the "**Device sensor ID**".
- vi. Set the Device sensor Name.
- vii. Set the "**Poll Interval**".
- viii. Click on the "  " to validate the addition of the device sensor.

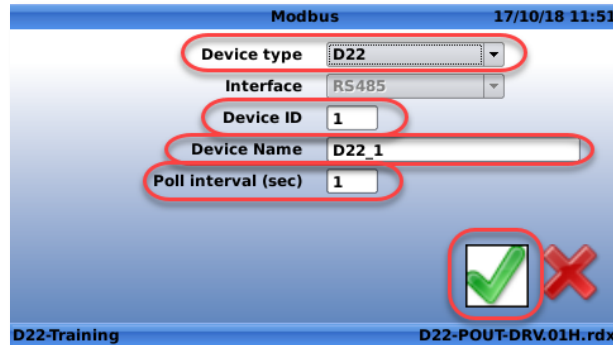

Modbus 17/10/18 11:51



Device type: D22

Interface: RS485

Device ID: 1

Device Name: D22_1

Poll interval (sec): 1

D22-Training D22-POUT-DRV.01H.rdx

- ix. The sensor is correctly added.

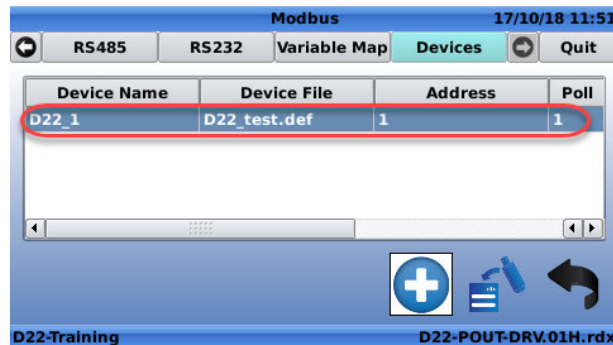

Modbus 17/10/18 11:51

RS485 RS232 Variable Map **Devices** Quit

Device Name	Device File	Address	Poll
D22_1	D22_test.def	1	1

D22-Training D22-POUT-DRV.01H.rdx

6. Go back to "**Main screen**" with long click "**OK**".
7. Go into "**Inputs**" menu with short click left.
8. The two read values have been added.

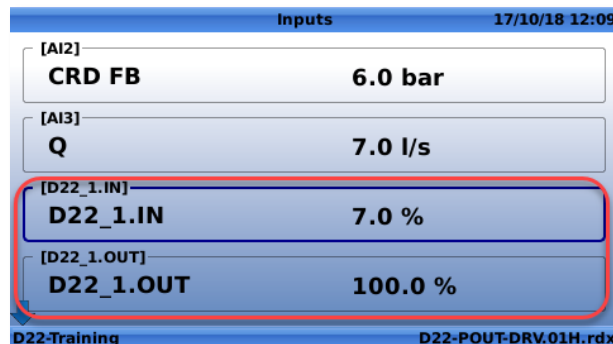

Inputs 17/10/18 12:09

[AI2]	CRD FB	6.0 bar
[AI3]	Q	7.0 l/s
[D22_1.IN]	D22_1.IN	7.0 %
[D22_1.OUT]	D22_1.OUT	100.0 %

D22-Training D22-POUT-DRV.01H.rdx

7 APPENDIX: ENGINE UPDATE INFORMATION

7.1 SINCE RELEASE 1.8.4 (17.10.2016)

7.1.1 CENTRALIZED UNIT CONFIGURATION

It is now possible to configure all the Inputs/Outputs and internal variables units of the D12 & D22 from a single menu, preventing inconsistencies and mistakes in conversions when configuring the units independently.

The Centralized Unit Configuration can be accessed from the "Settings" screen: *Long click Down* > "Unit Management".

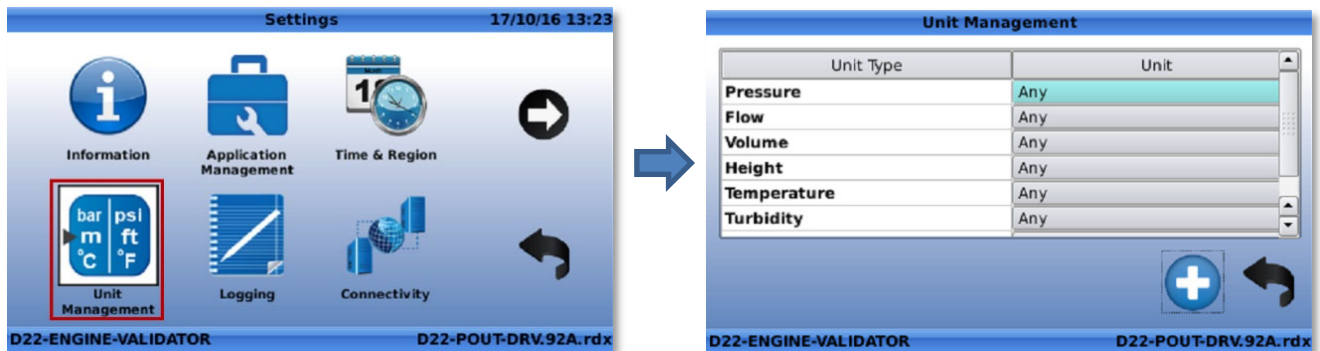

The user can select a unit to be applied for a type of physical value, and all the values will throughout the device menus will then be automatically changed.

By selecting "Any", the user can still manually change the units independently.

7.1.2 LATCHING SOLENOID SUPPORT

The D22/VC-22D now offers the capability to control Latching Solenoids via its SO1 and SO2 outputs. The Solenoid output type can be set in the "Output Configuration" screen (*Long click Right*).

7.1.3 LANGUAGE SUPPORT: FRENCH

Starting with R-Engine 1.8.4, French language display has been added for the D22. To select the language, go in the "Settings" screen: *Long click Down* > "Time & Region" > "Language" tab. A reboot of the device is needed to apply the changes.

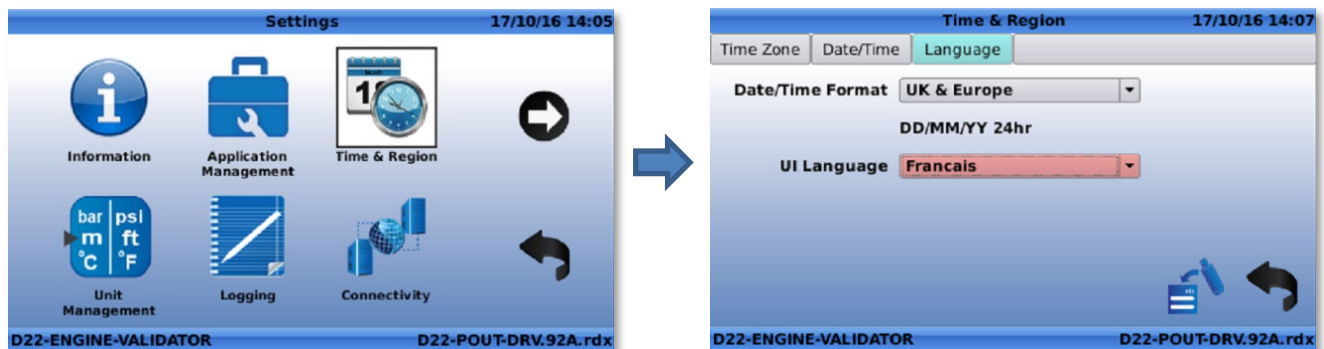

Note: The texts and images specific to a ValvApps will not be changed; only the texts relevant to the R-Engine will be translated.

7.2 SINCE RELEASE 1.9.0 (06.06.2017)

7.2.1 CONFIGURATION WIZARD

In order to ease the D22/VC-22D and D12/VC-12 device commissioning, a new tool has been implemented to go through the device start-up process step-by-step and configure the devices with the minimum information needed to get the system running.

This feature, called the "**Setup Wizzard**", avoids having to navigate in the menus at the time of the commissioning, preventing confusion, especially for people who are not very familiar with the CLA-VAL controllers.

Here are a few screenshots showing the steps of the "**Wizzard**" for a given ValvApps (D22-RES-SOL.02 - reservoir level control with solenoids).

Note that the "**Setup Wizzard**" will automatically show up the first time the unit is switched on. It can also be directly accessed/launched from the "**Advanced**" menu (*Long Click Down > Advanced*).



When the "**Setup Wizzard**" is launched, the user has 1 minute to react before it deactivates and the unit gets back to normal use.

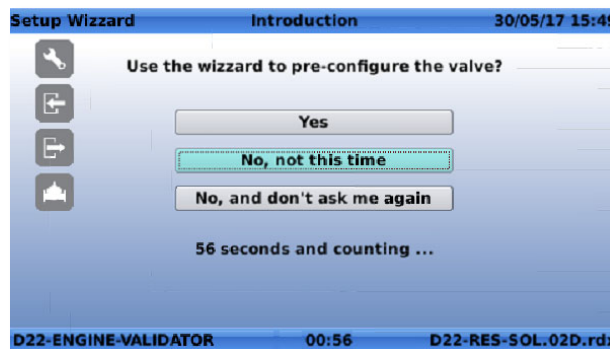

Selecting "**No, not this time**" will exit the "**Setup Wizzard**", but the latter will be launched again automatically after the next unit reboot.

Selecting "**No, and don't ask me again**" will exit the "**Setup Wizzard**", and it will not show up again, unless manually launched.

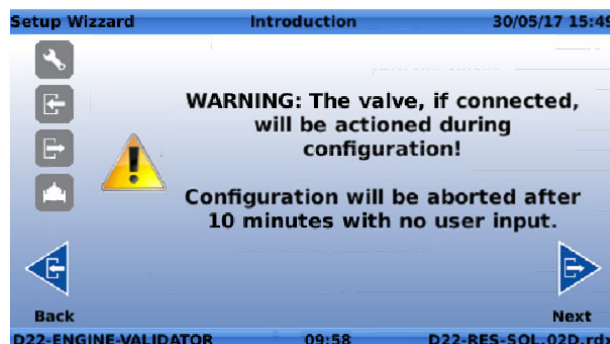

1. General configuration - Region, Time and Language.



Setup Wizard General 30/05/17 15:49

Where are you located?

Region: Europe

Timezone: (GMT+01:00) Amsterdam, Berlin, B

Language: English

Back Next

D22-ENGINE-VALIDATOR 09:54 D22-RES-SOL.02D.rdx

2. General configuration - Units.



Setup Wizard General 30/05/17 15:49

Unit Choice

Flow: l/s

Volume: m3

Pressure: bar

Level: m

Back Next

D22-ENGINE-VALIDATOR 09:57 D22-RES-SOL.02D.rdx

3. Inputs configuration.

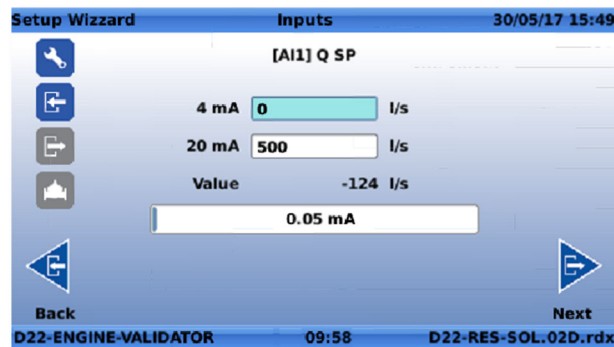

Setup Wizard Inputs 30/05/17 15:49

[AI1] Q SP

4 mA: 0 l/s

20 mA: 500 l/s

Value: -124 l/s

0.05 mA

Back Next

D22-ENGINE-VALIDATOR 09:58 D22-RES-SOL.02D.rdx

4. Outputs configuration.

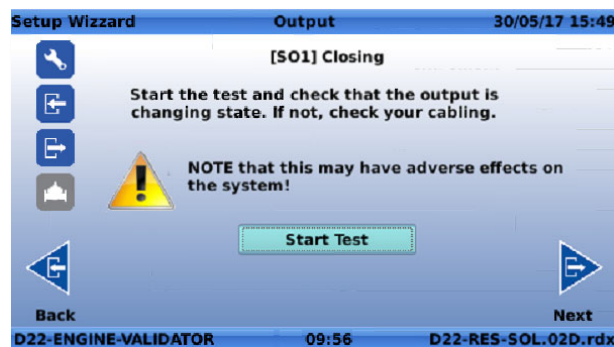

Setup Wizard Output 30/05/17 15:49

[SO1] Closing

Start the test and check that the output is changing state. If not, check your cabling.

NOTE that this may have adverse effects on the system!

Start Test

Back Next

D22-ENGINE-VALIDATOR 09:56 D22-RES-SOL.02D.rdx

5. Regulation details (if needed).

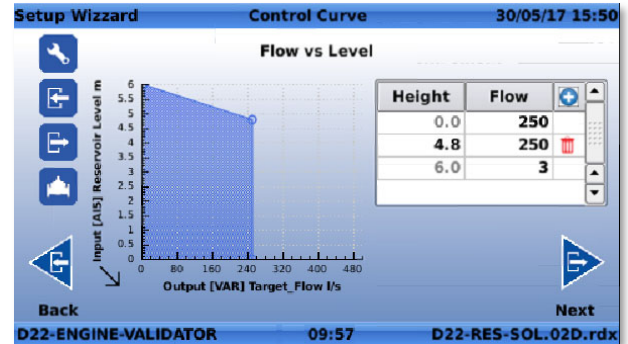
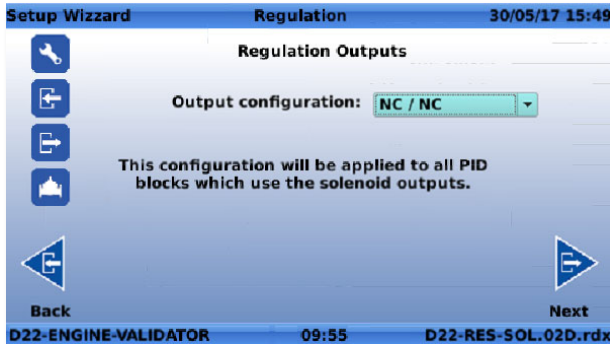

6. Communications configuration.

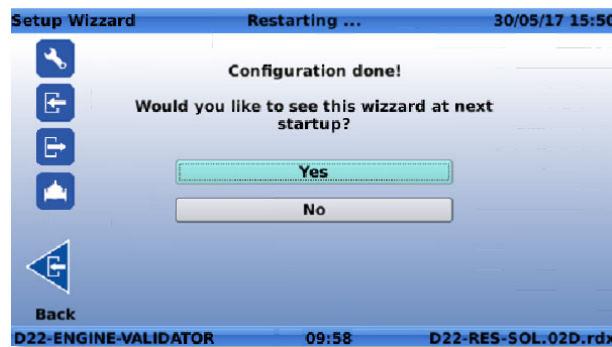
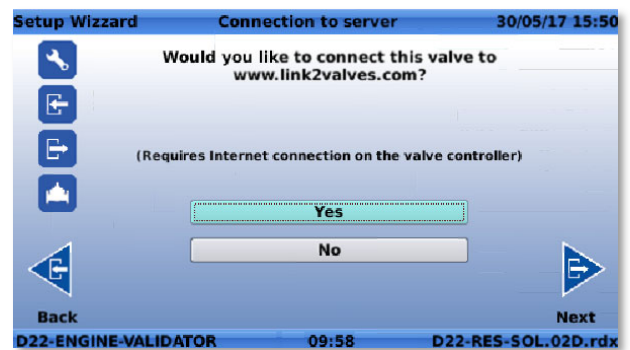
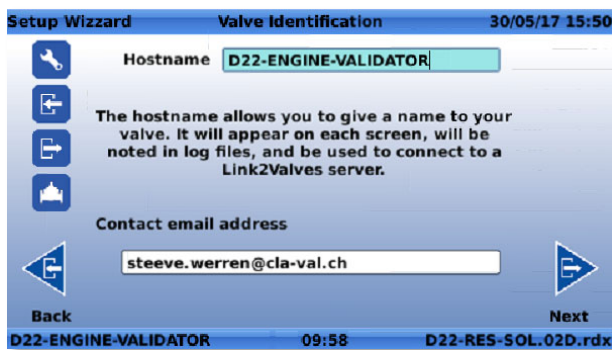

7.2.2 MODBUS OVERRIDE VIA UI / MODBUS DEBUGGER

This new feature has been implemented in order to help supporting/troubleshooting customers having issues connecting the D22/VC-22D to their system via Modbus.

The Modbus debugger can be accessed from the Modbus connectivity menu (*Long Click Down > Connectivity > Modbus*).

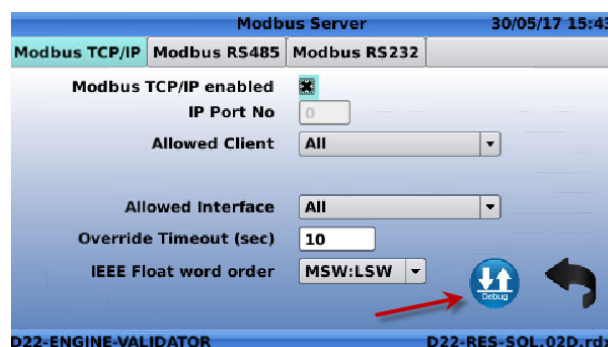

Before any frame is sent to the D22/VC-22D:

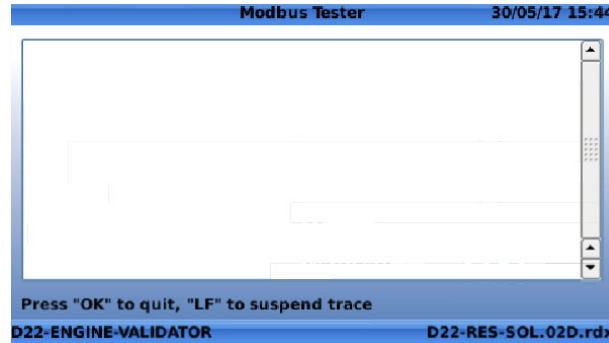

After 2 frames:

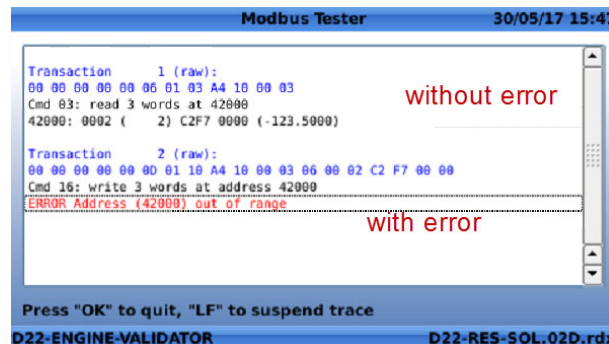

7.2.2.1 Control Curve Navigation Improvement

The navigation for setting/modifying the control curve has been improved by putting the point coordinates on the left, making the navigation more logical.

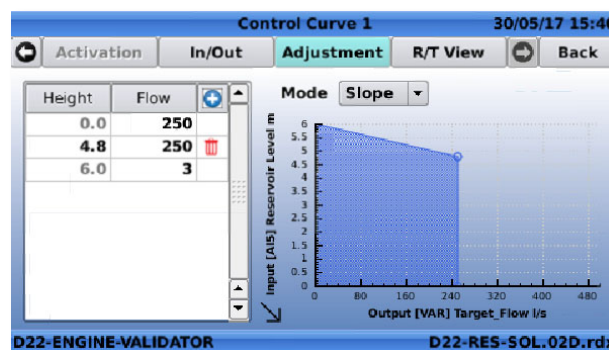

7.2.2.2 Automatic Output Conversion

Following up the centralized "Unit Management" feature included in the previous R-Engine version, the values are now automatically and immediately converted when changing the unit in the Configuration Screen (Long Click Left > Left for inputs, or Long Click Right > Right for outputs).

7.2.2.3 DP Metering

The DP metering feature (flow estimation as a function of the differential pressure and valve position) has now been implemented for CLA-VAL Europe valves and can be integrated in new CLA-VAL Europe ValvApps if needed.

7.2.2.4 Remove "!Actions!"

It is now possible to remove actions (*Long Click Up > !ACTIONS!*).

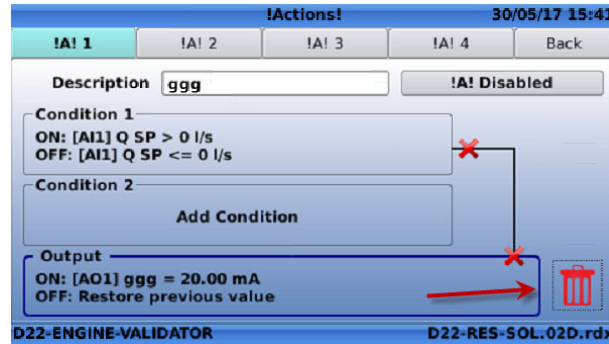

7.2.3 BUG FIXES

- ValvApps are backed-up automatically via HTTPS (previously only via FTP).
- When Internal Variables unit is set to "Time", and format set to seconds, display "s" and not "HHMM".

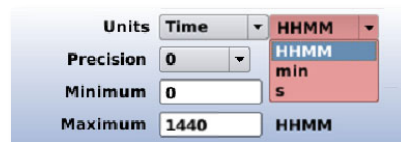

- PID: 100% setting blocked on D12.
- In "Action" Menu: Avoid D22 freezing when quickly changing tabs.
- LSP min/max Pressure settable within full range (0.11 → 0.10, 2.09 → 2.1)
- Log data / ValvApps backup saved on SD card
- Add capability to remove inputs added on-the-fly
- Correct 'ACTION' output status when using an input added on the fly in condition, or when enabling a new output with an 'ACTION'

7.3 SINCE RELEASE 2.0.1 (19.02.2018)

7.3.1 CLOSED LOOP CRITICAL POINT PRESSURE MANAGEMENT

This feature allows connecting a remote CV-Log logger located at a critical point and correcting the regulation profile of the D12 or D22 controller when over or under-pressure alerts are sent by the logger. A video explaining how the system works, and how to set it up is available here:

<http://share.cla-val.ch/public.php?service=files&t=b83fc0a6d7dfc4650b21a59804731ec3>

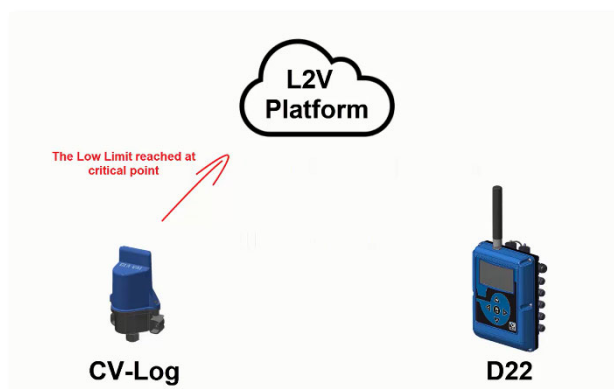

7.3.2 INTEGRAL AND DERIVATIVE PARAMETERS FOR PID

Up to now, the PID regulation only took into consideration the proportional factor (P), which is sufficient for most of the applications. However, in some applications it might be difficult to reach proper regulation, for instance when a very precise control is needed for a very small reservoir, which requires the usage of Integral and Derivative factors (I and D) of the PID. Therefore, integral and derivative factors of the PID control loop have been added back.

7.3.3 DP METERING ON D12

The DP Metering feature, allowing calculating flow with differential pressure and valve position sensor has been added to the D12 controller. Note that this feature needs to be added/declared in the ValvApps in order to be used, thus please specify at the time of ordering if needed.

7.3.3.1 Input Calibration Menu

The input calibration menu (red screen), which was not working properly has been corrected.

7.3.3.2 DPM - Add Custom Table

It is possible to add a custom table for the DPM calculation to tweak calculation in order to better match reference flowmeter measurements.

7.4 SINCE RELEASE 2.1.0 (20.03.2018)

7.4.1 POSSIBILITY TO ADD CONTROL CURVE ON THE FLY

This feature re-organizes the control curves into a menu and allows creating up to 8 Control Curves manually “on-the-fly”.



7.4.2 INITIAL VALUE FOR TOTALIZER FUNCTION

It is now possible to set a starting value for the totalizer feature.

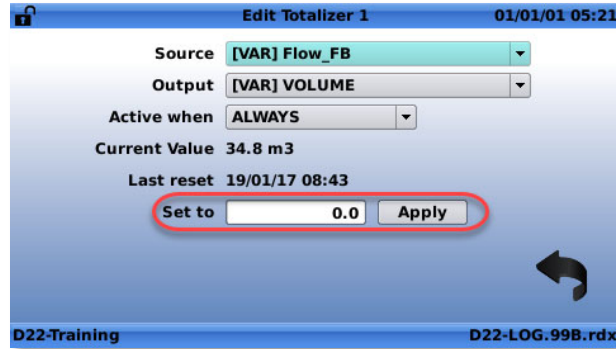

7.4.3 INITIAL VALUE FOR A COUNTER DIGITAL INPUT

This feature allows setting a starting value for a counter digital input of the type "DI_C".

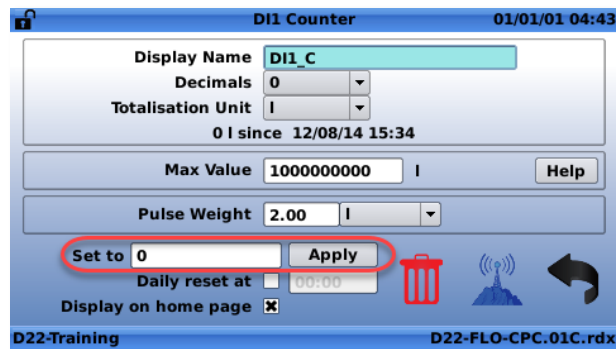

7.4.4 MODBUS - INTEGER VALUES TABLE AND ADDRESSING

A new Modbus table has been created for supervision systems not supporting decimal values, and thus requiring integer numbers for the inputs and outputs values.

The integer Modbus table, starting at the Modbus address 44000, provides inputs and outputs values into integer format according the decimal precision, as shown hereafter:

I/O	Value displayed on D22	Decimal parameter	Read on Integer Modbus
AI1 (Q Set Point)	582	0	582
AI1 (Q Set Point)	582.3	0.0	5823
AI1 (Q Set Point)	582.31	0.00	58231

In addition, some Supervision Systems set the command in the 1st digit of the Modbus address.

For example: Sending 42000 to execute the command "4" at the address "2000", which was not supported by the D22 up to now. To comply with such systems, the R-Engine version 2.1.0 now has the capability to be configured to "ignore" the first digit of the Modbus address (called "modulo" or address "shift").

7.4.4.1 Closed Loop Critical Point Pressure Management

The alarm recovery algorithm has been improved to optimize the usage.

7.5 SINCE RELEASE 2.2.0 (03.07.2018)

7.5.1 INTERNAL VARIABLE AVAILABLE INTO MODBUS TALE

It is now possible to read/write via Modbus all the internal variables available in the display panel (Short Click Down).
The list of all available variables can be found in a new tab "Variable List" in the Modbus Menu.

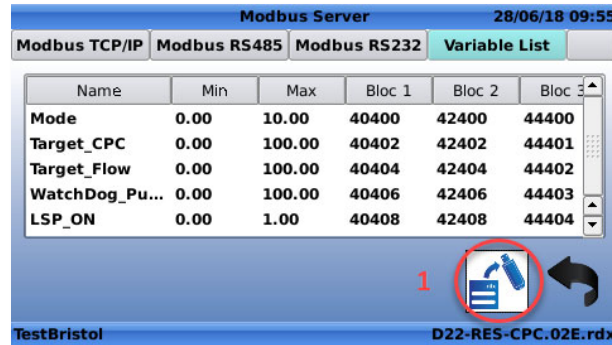

Name	Min	Max	Bloc 1	Bloc 2	Bloc 3
Mode	0.00	10.00	40400	42400	44400
Target_CPC	0.00	100.00	40402	42402	44401
Target_Flow	0.00	100.00	40404	42404	44402
WatchDog_Pu...	0.00	100.00	40406	42406	44403
LSP_ON	0.00	1.00	40408	42408	44404

The list of variables with their information (min/max range, and Modbus register address) can be exported to a USB stick by pressing the export to USB icon (1).

7.5.2 BUG CORRECTION

The following bug resolution has been implemented in the R-Engine version 2.2.0.

7.5.2.1 ValvApps Remote Backup (Communication)

When remote backup of the ValvApps to FTP server (or Link2Valves server) is enabled, it was possible that the PID process got corrupted during the backup process (only when a PID command was changed during the process). This issue has now been resolved.

7.6 SINCE RELEASE 2.3.1 (26.10.2018)

7.6.1 E-DRIVE-34 FULL INTEGRATION (VIA MODBUS)

The e-Drive-34 actuator is now fully interfaced to the D22 controller via its Modbus RS-485 interface, connected to the e-Drive-34 SOURIAU circular connector.



IMPORTANT: this feature requires the e-Drive-34 actuator to be loaded with firmware version 4.03 or higher!

7.6.1.1 Signal Interface

Interfacing an e-Drive-34 actuator to the D22:

1. Turn off the D22.
2. Connect the circular plug cable on the e-Drive-34 and D22.
 - a. According this wiring table:

Circular plug cable	Designation	D22	e-Drive-34
1	24V	V+	A
2	0V	V-	B
3	GND	RS-485 GND	C
4	485A	RS-485 485A	D
5	485B	RS-485 485B	E
6	Libre	-	F

3. Turn on the D22.
4. Go into **"Settings"** (long click down) > **"Connectivity"** > **"Modbus"**.
5. In the **"RS-485"** tab.
 - a. Enable the checkbox to allow **Modbus RS-485** connection.
 - b. Set **"Line Speed"** at **"9600"** baud.
 - c. Set **"IEEE float word order"** to **"MSW:LSW"**.
 - d. Check the checkbox to **"Run as Modbus master"**.

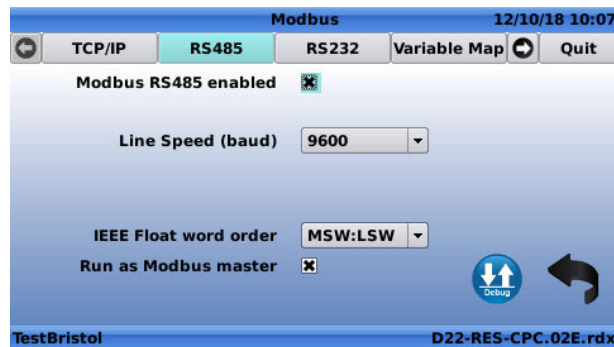

6. In the **"Devices"** tab (right click to reach the tab).
 - a. Click on the **"+"** button.



7. Create the Modbus device
 - a. Set "Device type" to "eDrive34".
 - b. "Device ID" to the slave address of the e-Drive-34 (default: 1).
 - c. Give a name to the device.
 - d. Set the "Poll interval" (default: 1 second).
 - e. Click on the "green checkmark" to add/create the device.

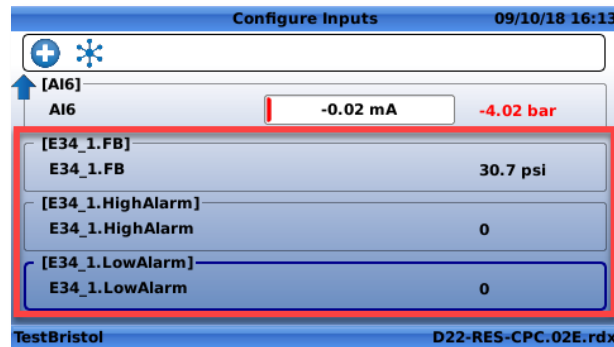

- f. The e-Drive-34 is created and now controllable via Modbus.



Once the actuator is interfaced to the D22 advanced controller, the following e-Drive-34 signals are available:

- Inputs:
 - <name_of_device>.FB -> Feedback
 - <name_of_device>.HighAlarm -> HighAlarm
 - <name_of_device>.LowAlarm -> LowAlarm
- Output:
 - <name_of_device>.Cmd -> Command

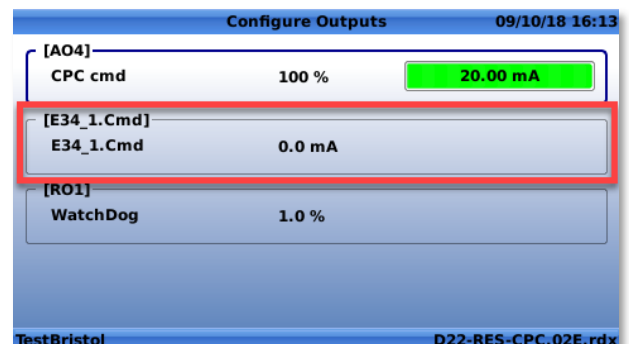
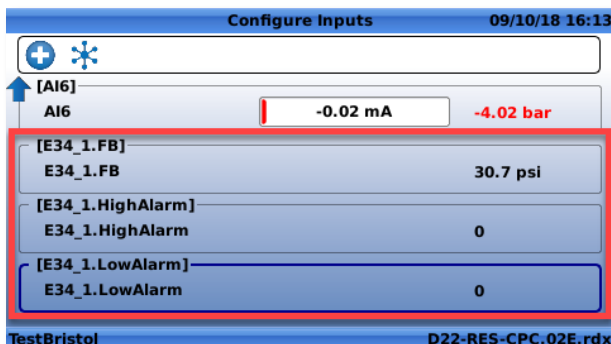

All the inputs/outputs can be used into followings D22 regulation blocks:

- PID
- Control Curve
- Input recopy
- Signal retransmission
- Actions

7.6.2 CALIBRATION

It is now also possible to calibrate the e-Drive-34 with a D22 controller (via its Modbus RS-485 interface), preventing the need of a computer in the field. The D22 graphical interface replicates the e-Drive-34 PC software information/commands, with an improved user experience (context-esensitive assistance). To navigate to the e-Drive-34 user interface: *(Long click up)* "Configuration" > "eDrive34".

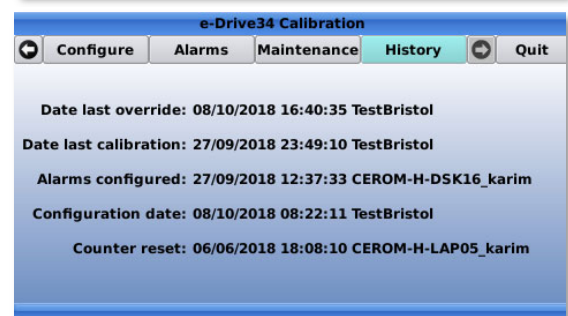
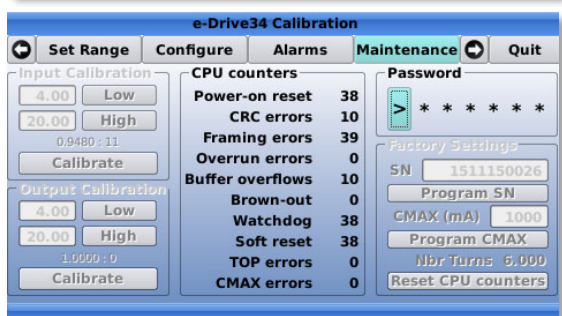
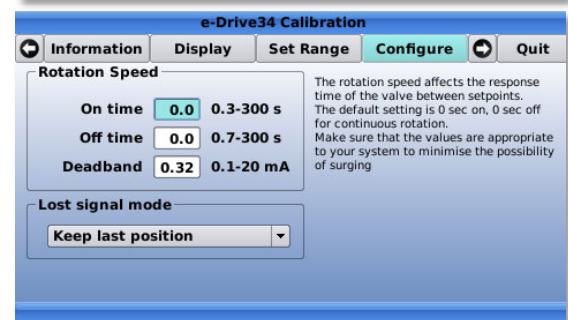
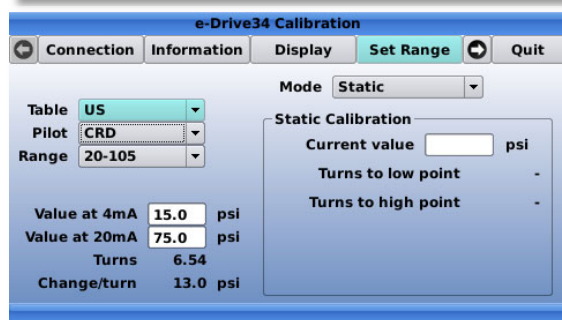
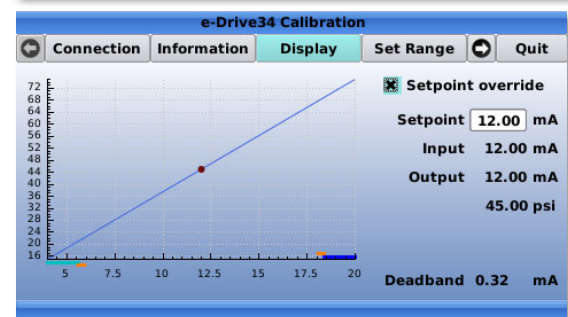
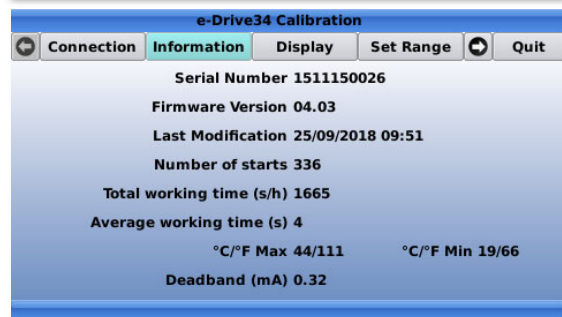
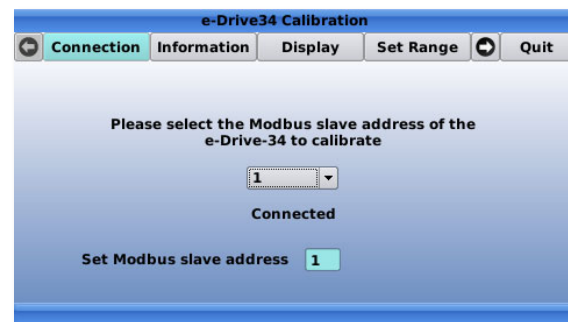
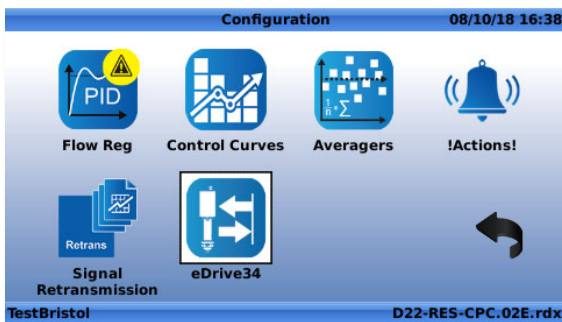

How to access the menu:

Once the e-Drive-34 is interfaced (see paragraph 7.6.1.1), click on the "eDrive34" icon into "Configuration" menu (Long click up)

1. By default, the "Modbus slave address" of an e-Drive-34 actuator is set to 1.
2. It is possible to connect up to five e-Drive-34 to a D22, by setting a different Modbus slave address for each actuator, before connecting them at the same time.
3. When changing settings, the button "Write calibration" appears. Click on this button to save changes.
4. The "Maintenance" tab is protected by password (252825), providing access only to advanced users, and avoiding unwanted misuse.

7.6.3 INTERFACE FOR GENERIC MODBUS SENSORS

In addition, the new R-Engine 2.3.1 software also allows the capability to interface any Modbus RS-485 sensor to the D22 advanced controller.

All the values of the sensor can be used into followings regulation blocks:

- PID
- Control Curve
- Input recopy
- Signal retransmission
- Actions

Refer to the D22 User Manual for more information on how to create a sensor interface definition file in the D22.

Interfacing a Modbus RS-485 Sensor to the D22:

1. Turn off the D22.
2. Connect the sensor and D22.
3. Turn on the D22.
4. Go into "Settings" (long click down) > "Connectivity" > "Modbus".
5. In the "RS485" tab.
 - a. Check the checkbox to enable "Modbus RS485"
 - b. Set "Line Speed" at "9600" baud
 - c. Set "IEEE Float word order" to "MSW:LSW"
 - d. Check the checkbox to "Run as Modbus master"

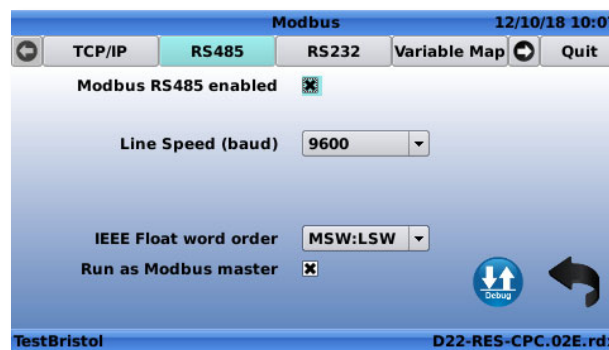

6. In the "**Devices**" tab (right click to reach the tab).
 - a. Click on the button to import file.

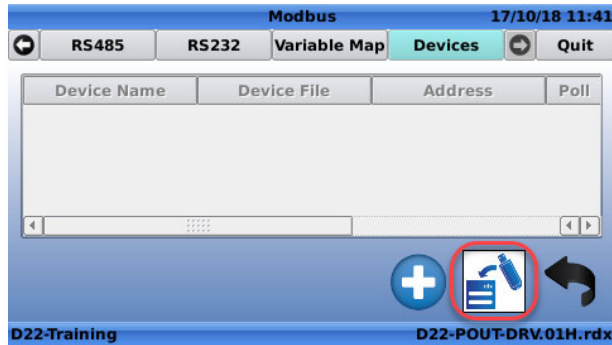

- b. Browser into USB key to reach the sensor interface definition file and click "**Ok**".
 - c. Click on the "+" button to add the new sensor.
7. In the "**Devices**" tab (right click to reach the tab).
 - a. Click on the "+" button.



8. In the window to create the Modbus device.
 - a. Set "**Device type**" on the name of the sensor (given by the sensor interface definition file).
 - b. Set "**Device ID**" to the slave address of the sensor.
 - c. Give a name to the device.
 - d. Set the "**Poll Interval**", by default 1 second.
 - e. And finally click on  to add/create the device.

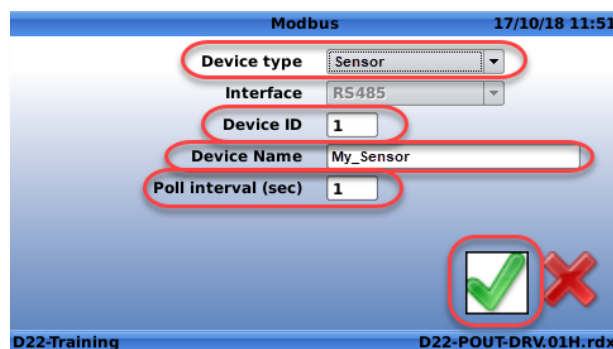

f. The e-Drive34 is created and now controllable by Modbus.



g. These inputs/outputs will can be configured as a normal input/output. Example of a specific D22 sensor interface definition file.

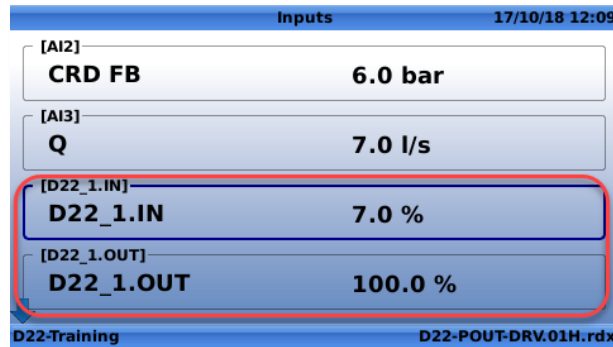

7.6.4 PID

7.6.4.1 Multi-Zone Tuning

It is now possible to select any input, or internal variable, to create a multi-zone for a PID.

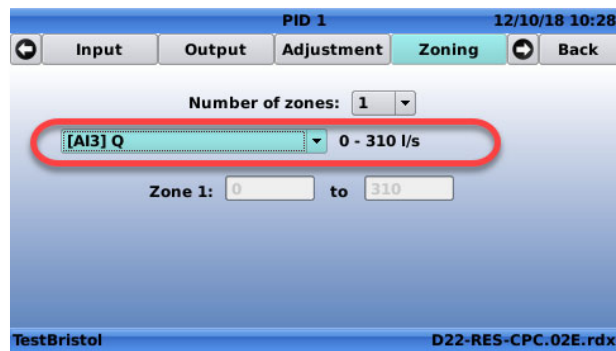

7.6.4.2 Increase Deadband Decimal

The new R-Engine 2.3.1 allows better resolution of up to 2 digits.

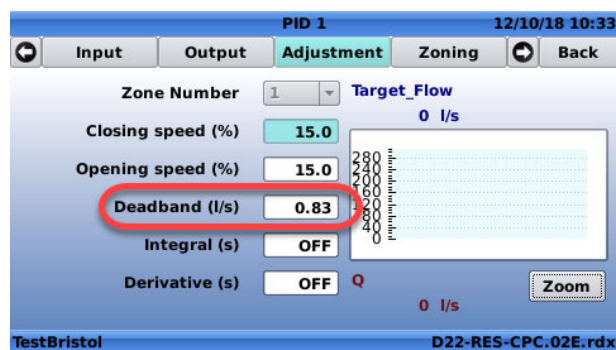

7.6.4.3 Logfile Date-Time Format

The date-time format for the "TIME" column in the *.CSV log file is exported according the date-time format set into the D22. See hereafter examples:

Date-Time "UK & Europe":

	MAXI	
TIME (LE)	TIME	R
1534158949	13.08.2018 13:15	
1534158889	13.08.2018 13:14	
1534158785	13.08.2018 13:13	
1534158725	13.08.2018 13:12	
1534158665	13.08.2018 13:11	
1534158605	13.08.2018 13:10	

Date-Time "USA":

	MAXI	
TIME (LE)	TIME	R
1534159009	08/13/2018 01:16:49 PM	
1534158949	08/13/2018 01:15:49 PM	
1534158889	08/13/2018 01:14:49 PM	
1534158785	08/13/2018 01:13:05 PM	
1534158725	08/13/2018 01:12:05 PM	
1534158665	08/13/2018 01:11:05 PM	

7.6.4.4 Communication Data Consumption Optimization

Some improvements to reduce the overall data consumption of the communicating devices has been implemented.

7.6.4.5 Wizzard Tool

It is now possible to configure into the "Wizzard" input setting a default action in case of signal loss.

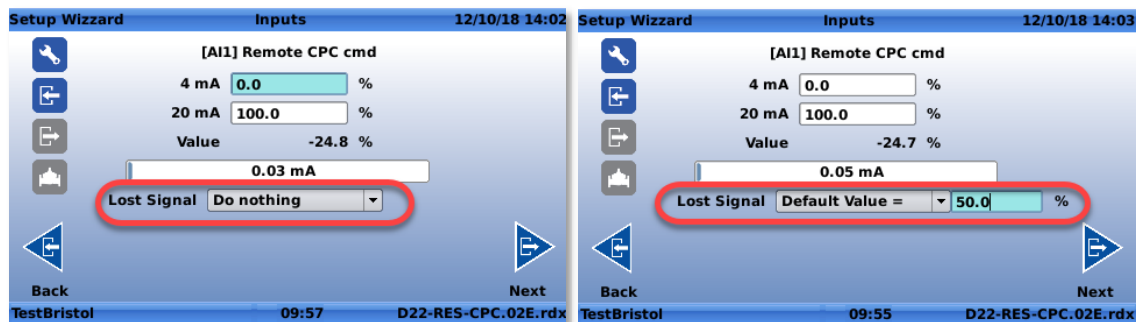

7.6.5 BUG CORRECTION

The following bug resolution has been implemented in the R-Engine version 2.3.1.

7.6.5.1 The Use of the «@» Character

In the last version of R-Engine software version, a bug was introduced preventing the use of «@» character in the contact field (in the "Information" menu and in the "Wizzard"). This is now corrected.

7.7 SINCE RELEASE 2.4.0 (08.02.2019)

7.7.1 WIFI COMMUNICATION CAPABILITY

The D22 / D12 & D11 controllers now implement a WiFi interface via a dongle connected on a USB port, allowing a more easy and robust VNC connection than BlueTooth on a computer or tablet.

The WiFi USB dongle CVEU part number is MEX-CB-LM007.

⚠ IMPORTANT: this feature requires a dongle WiFi LM007-1051 (on the right in the picture below) or Netgear N300 (on the left in the picture below). Other dongles might not be compatible!

7.7.1.1 Setting up the WiFi Interface on the D22 Controller

1. Connect the WiFi dongle on a USB port.



2. Navigate to **"Settings"** (long click down) > **"Connectivity"** > **"Next"** page > **"Wireless"**.
3. In the **"WiFi"** tab.
 - a. Enable the checkbox to allow **WiFi** connection.
 - b. **"WiFi AP name"** is set as the *Device Name*.
 - c. Set **"WPA key"** if needed. By default the key is 0000 followed by the 4 last IMEI digits.
 - d. **"IP address"** is set to 10.255.255.1 by default. There is no need to change it.

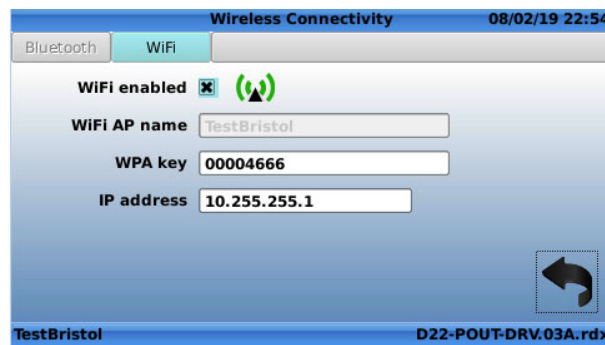

4. Exit the screen by clicking on the black arrow.
 - a. Click **"OK"** on the pop-up message.



5. On your laptop, check the "Wireless network" and select the D22 device to connect to.

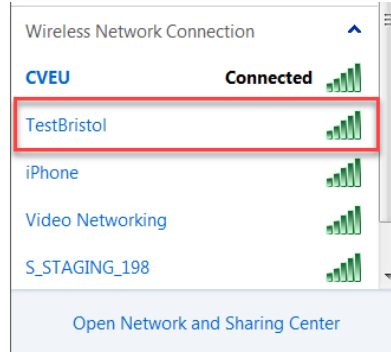

- a. When the Wireless is connected, WPA is asked (password). Enter the "WPA Key" used in step 3c.
- b. Open a "VNC" software and write the IP address used in step 3d (10.255.255.1), click "Connect".

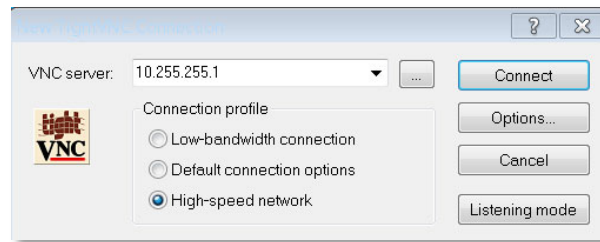

- c. Use the VNC to navigate.

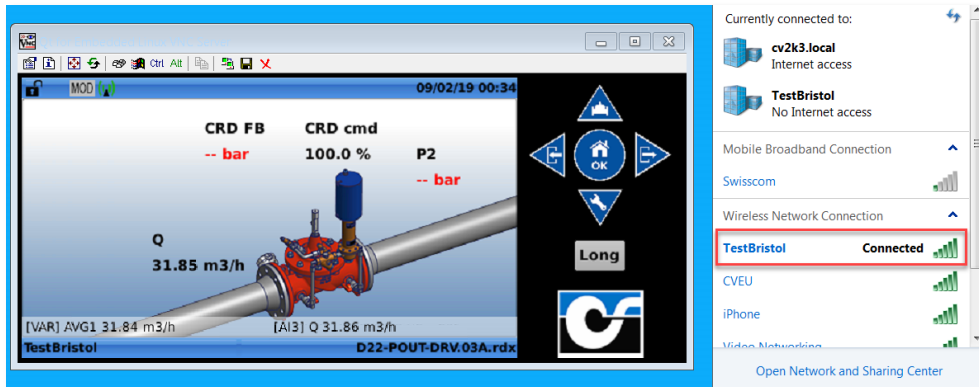

7.7.1.2 Setting up the WiFi Interface on the D11 & D12 Controllers

In the D11 and D12 controllers, the WiFi is activated by default and is therefore immediately available, provided a WiFi dongle is present.

To interface to the controller via WiFi, follow the same procedure as in step 5 of the D22 interface.

Note:

The password (WPA Key) is displayed on the OLED display for 10 minutes when switching on the device.

7.7.2 PID & CC STATUS ICON

The new R-Engine 2.4.0 software also shows the status of the PIDs and Control Curves directly on the icons of the configuration screen.

- **Red:** PID / CC is not active.

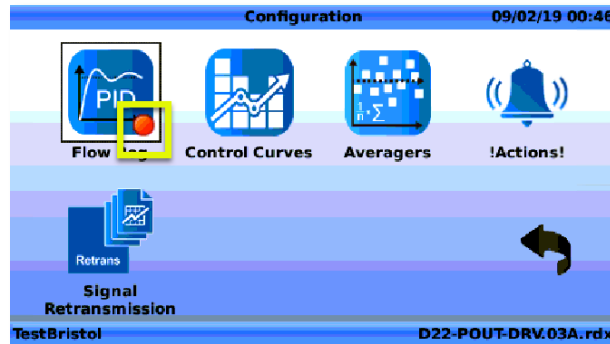

- **Green:** PID / CC is active

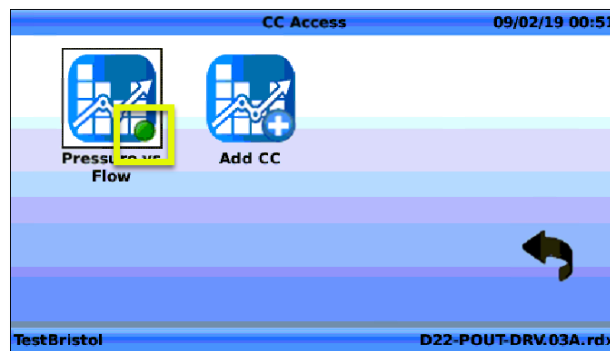

7.7.2.1 Improve Data Transfer Security via HTTPS

Starting with R-Engine version 2.4.0, the D12 and D22 controllers are forced to use the latest standard TLS security protocol version 1.2, when communicating via HTTPS (i.e. with Link2Valves).

7.7.2.2 Password Reactivation

For devices where a password protection is set, when entering the password the device would remain unlocked unless the password was manually reactivated. A timer has now been added, and the controller will automatically lock back after 20 minutes of inactivity.

7.7.3 BUG CORRECTION

Here is a list of the main bugs resolved in the R-Engine version 2.4.0.

7.7.3.1 Quick Navigation (Right/Left) User Interface Crash (R-UI)

In some cases, when navigating quickly in the control curve menu, the controller could reboot or get blocked. This should be now resolved.

7.7.3.2 Special Characters In APN Settings

In the last version of the R-Engine software, a bug was introduced preventing the use of "@" and some other special characters in the APN settings. This is now corrected.

7.7.3.3 Inverted Solenoid Command in French Interface

The translation in French inverted the Solenoid command in the PID Output tab. This is now corrected.

7.7.3.4 Time Zone & Linux Epoch Wrong in AreaS without Daylight Saving

The Linux Epoch information in the CSV log file was wrong for countries that do not use daylight saving. This is now corrected.

7.8 SINCE RELEASE 2.5.0 (06.08.2019)

7.8.1 ZERO SET POINT CLOSURE (ONLY D22)

In step by step applications (solenoid command), a setting can be adjusted on solenoid closure to force the valve fully close, whenever the valve position is within the deadband of closure.

7.8.1.1 Features Menu

- Go into the "PID" (long click up) > "Output" tab.

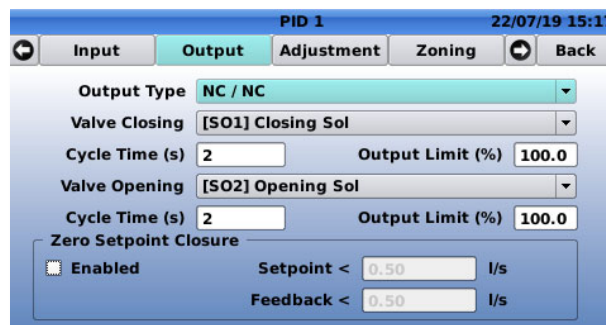

The screenshot shows the 'PID 1' configuration screen, specifically the 'Output' tab. The 'Zero Setpoint Closure' section has a checkbox labeled 'Enabled' which is currently unchecked. The 'Setpoint <' and 'Feedback <' fields are both set to 0.50 l/s.

- Enable the checkbox "Zero Setpoint Closure" to allow the setting of "Setpoint" and "Feedback".
- Adjust "Setpoint" and "Feedback" values to activate the feature.

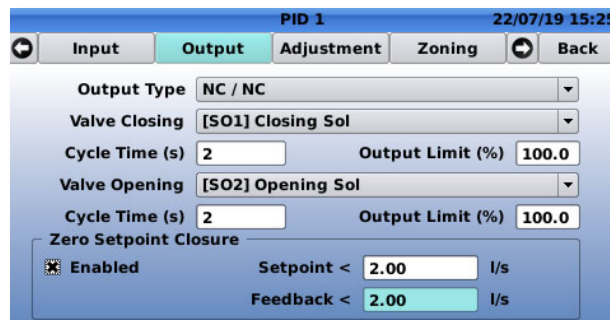

The screenshot shows the 'PID 1' configuration screen, specifically the 'Output' tab. The 'Zero Setpoint Closure' section has a checkbox labeled 'Enabled' which is now checked. The 'Setpoint <' and 'Feedback <' fields are both set to 2.00 l/s.

When both values are reached, the "Zero Setpoint Closure" provides on "Closing solenoid" 100% activation to close fully the valve.

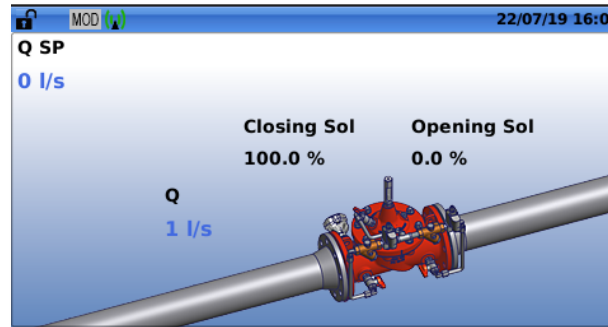

7.8.2 PID BUMPLESS TRANSFER WITH MULTI PID (ONLY D22)

When using multiple PID regulation, a progression Ramp from the starting point to the setpoint can be used when switching between the 2 PID processes, instead of jumping directly to the new setpoint.

Here an example of PID control before R-Engine update and after with PID Bumpless implemented.

Switch reaction between 2 PID control before R-Engine update

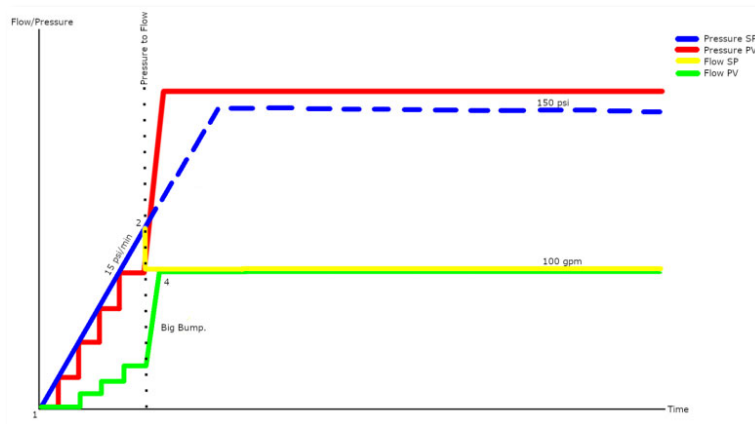

Switch reaction between 2 PID control after R-Engine update

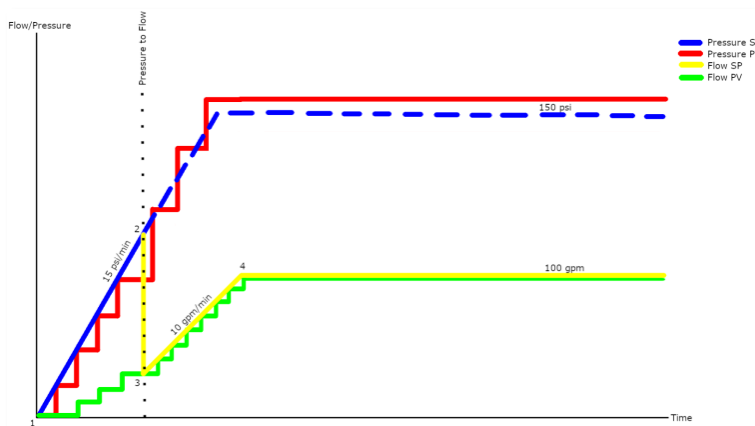

7.8.3 MODIFY THE VALVAPPS NAME WHEN REGULATION IS MODIFIED

A number is added at the end of the ValvApps name when the configuration parameters are changed into the device. This feature helps identifying easily the modifications made by a user in the regulation configuration.

In addition, when the ValvApps is saved on a USB key, the name of the device is now added to the ValvApps name, avoiding to erase previously saved versions of the same ValvApps.

The name of a ValvApps is changed if some modifications are made. The list of modifications is as follows:

- addition/deletion/modification of an action
- addition/deletion/modification conditions for a CC
- addition/deletion/modification of conditions for a PID
- addition/deletion/modification input or output
- addition/deletion/modification average
- addition/deletion/modification retransmission
- addition/deletion/modification recopy
- modification VAR
- modification DPM
- modification log

When a modification as listed above is made, the ValvApps name is renamed as per the following example: **D22-POUT-DRV.95B.rdx** will be renamed after modification to **D22-POUT-DRV.95B.REV000.rdx**.

7.8.4 DELAY OPTION IN "ACTION" MENU

This option provides the capability to add a delay prior to activating an action. When the condition is true, a time delay will be applied before the corresponding action becomes effective. Useful when you use flow condition for example. Some activation options have also been added and can be combined with the action delay (minimum activation / one shot).

Function Activation / Deactivation Delay & Minimum Duration

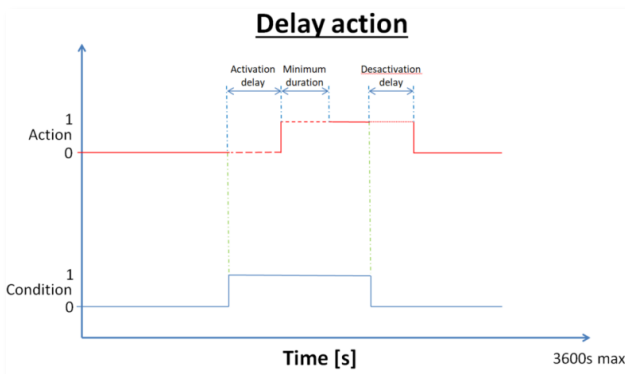

Delay Options

Activation delay (s) Deactivation delay (s)

Min. duration (s)

One-shot

Function one shot

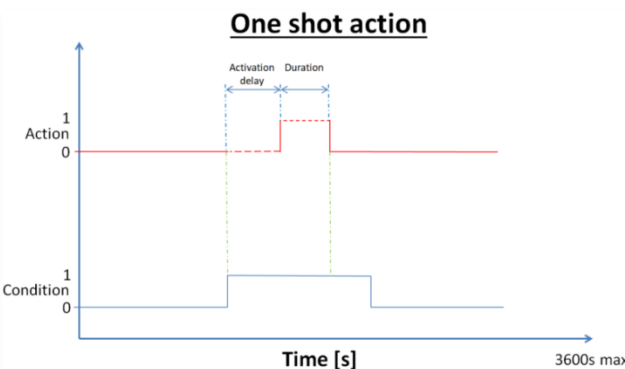

Delay Options

Activation delay (s)

Duration (s)

One-shot

7.8.5 EXTENSION OF CONTROL CURVES ACTIVATION BASE ON A TIME PERIOD CONDITION

In addition to the existing enabling conditions for a CC, a period is now added to define date & time of activation and deactivation.

Here is an example of the period configuration:

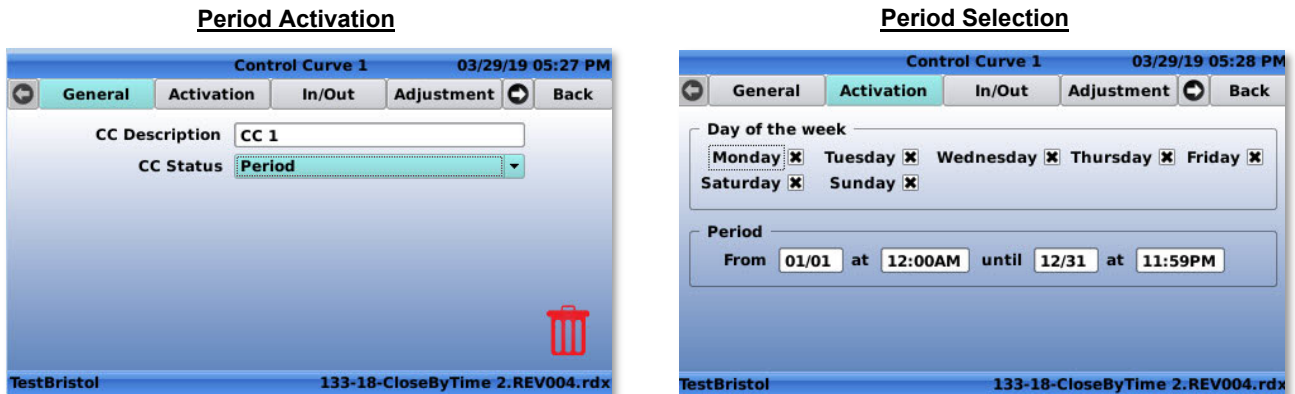

7.8.6 "OPTICON": SOLENOID OUTPUT POWER CONSUMPTION OPTIMIZATION (D22 ONLY)

This feature minimizes the power consumption on the solenoid output of the D22, thus decreasing the temperature of the solenoid, which minimizes the risk of blocking in hard water conditions.

The function work in digital or PWM (no necessary in latching type).

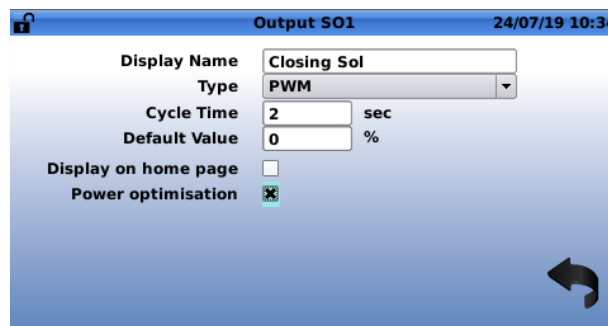

7.8.7 IMPORT AND/OR EXPORT FILES VIA THE WEB INTERFACE

After the WiFi interface implementation in version 2.4.0, this feature provides the capability to upload/download files to/from a device via WiFi connection.

Please note Browser compatible & tested are: Mozilla Firefox / Chrome / Edge

On D11 & D12, the "Web interface" is activated by default and IP address connection is <http://10.255.255.1/>

On D22, you should activate "Web interface" into menu "Connectivity", second page.

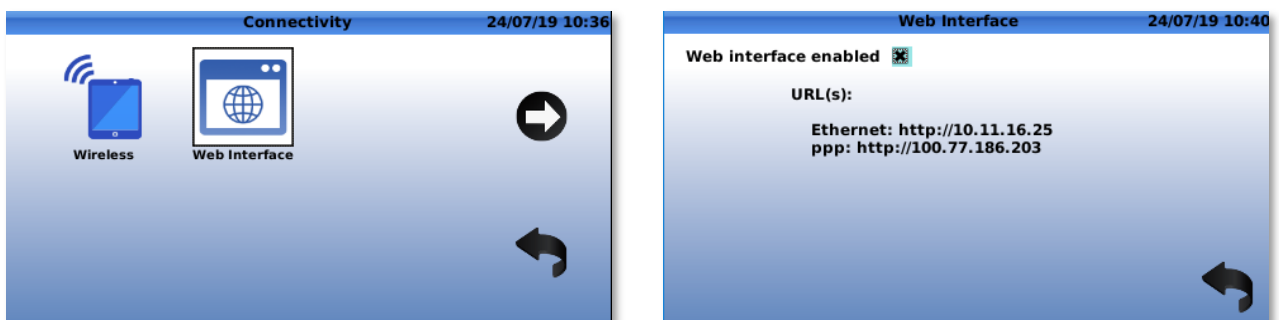

Check the IP address into "**Web Interface**" then establish connection with your Browser.

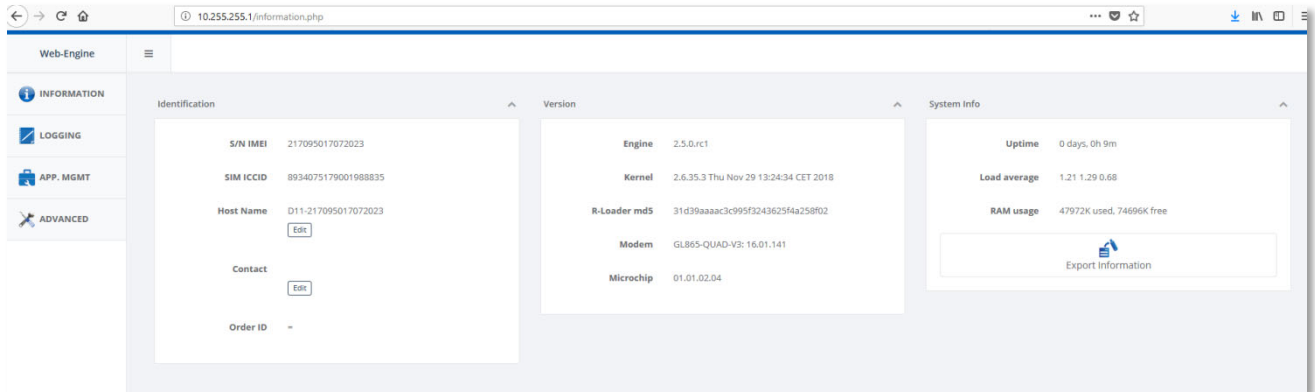

7.8.8 MODBUS NEW DATA MODEL (NEW TABLE)

Table Modbus are completely reviewed to provide simpler interface with SCADA request. The old Modbus table is called "**Cla-Val table**" and the new table is called "**Standard table**". By default, after an update R-Engine will keep the table used before the update. In other words, if you update with the version 2.5.0, R-Engine will keep the "**Cla-Val table**" activated, thus ensuring the existing connection with the SCADA system.

You will have the ability to select which table you want into "**Modbus**" menu. The biggest change between two tables are: to which address the value is stored and the introduction of the concepts of physical value and logical value.

The complete table is into the "Modbus_tables.xlsx" file attached to the "What's new (06.08.19)" email (this email).

Here is a small example of overriding AO3:

CLA-VAL table:

To override the value of AI3 initially requires two or three write operations:

- Write the desired value to registers 42007 and 42008 (using either two single-word writes or a single 2-word write operation)
- Write 1 to address 42006 to apply the value in the holding register

Standard table:

To override the value of AI3 initially requires two or three write operations:

- Set bit 2 of address 40017 to 1 to apply the value in the holding register
- Write the desired value to registers 42040 and 42041 (using either two single-word writes or a single 2-word write operation)

Note:

- Due to the concepts of physical value and logical value, it is imperative to first activate the override and then assign the desired value to the correct register address.
- In the interval between the activation of the override and the assignment of the value, the taken override value will be the actual value of the logical value.
- The physical value registers will always contain the measured value on the input or output even if no sensor is connected (bit Out of Range at 1)
- The logical value registers will be the same of the physical value registers except if a local override is applied or if the input is used like a RSP/LSP in LSP mode.

7.8.8.1 Force Devices to Use TLS 1.2 and Certificates

Security improvements between device & server Link2Valves have been implemented.

7.8.9 BUG CORRECTION

The following bug resolution has been implemented in the R-Engine version 2.5.0.

7.8.9.1 Log Export on USB Broken

This bug was introduced into version R-Engine 2.4.0. Fixed into this version.

7.8.9.2 R-UI Crash After Modem Busy Error

Some improvements to not reboot after R-Ui crash with Modem busy error have been implemented.

7.9 SINCE RELEASE 2.6.0 (04.05.2020)

7.9.1 POSSIBILITY TO USE CV-LOG ALERTS IN ACTION (ONLY D22)

This feature allows you to perform an action on the D22 when a high or low alarm is sent from a CV-LOG to Link2Valves.

The D22 needs to be in the same Link2Valves organization as the CV-LOG, or in a parent organization (above the one where the CV-LOG is located).

1. Go into the "**!ACTION!**" (long click up) > "**!A! 1**".

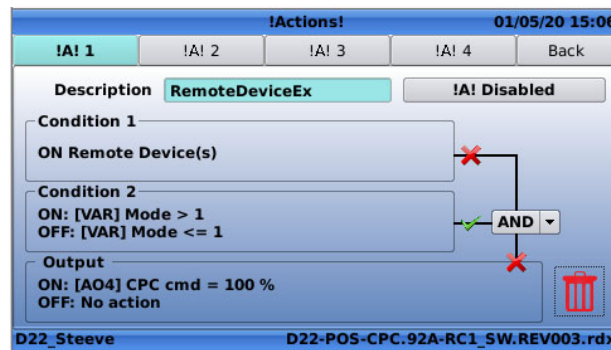

2. Go into the "**Condition 1**" to configure it. And select "**Remote Devices**" at the bottom of the list.
3. Select and click on the "**View/Edit Device List**" button.
4. Select and click on the  button then on the "**Refresh Device List**" button to refresh the available CV-Log. Wait until the end of the refresh.

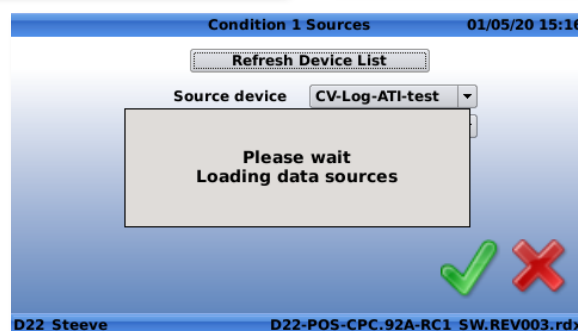
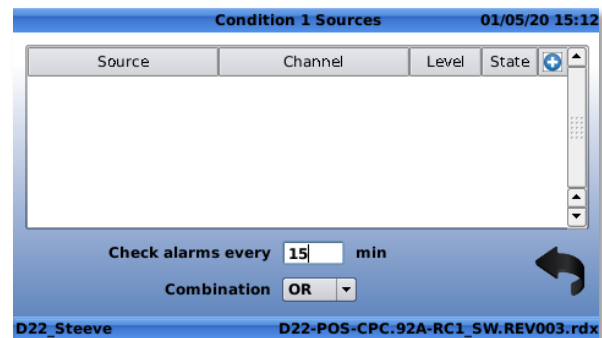
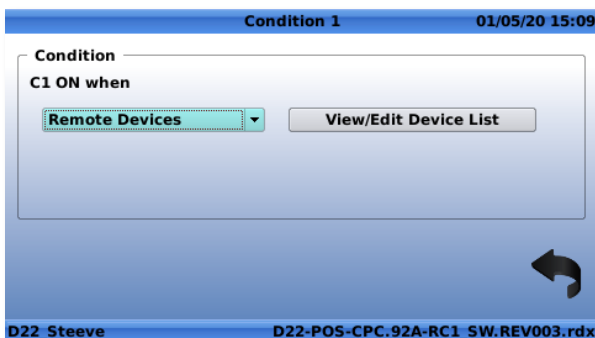

5. It is now possible to select the "**Source device**", that will be the desired CV-Log. When selected, click "**OK**", that will update the list of the channel available for the selected CV-Log.

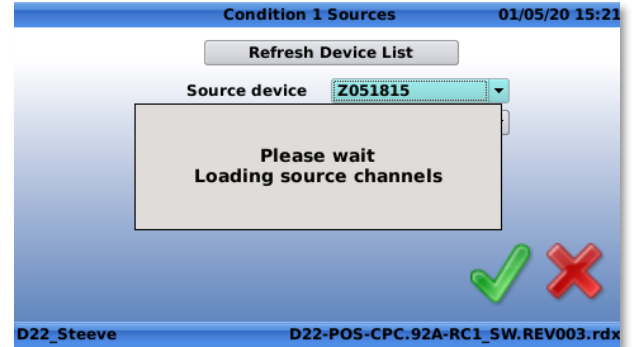

6. Select the "**Source channel**" of the selected CV-Log.

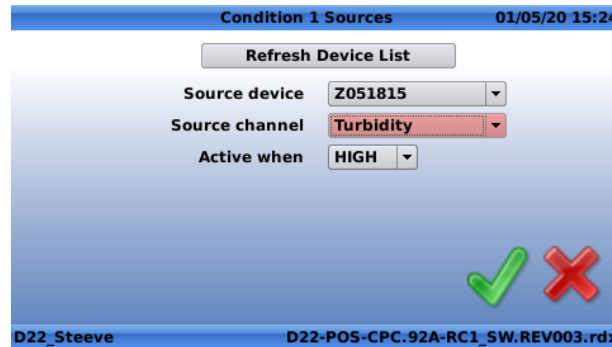

7. It is mandatory to select when the condition will be active with the "**Active when**" choice.

Two options:

- **HIGH:** When the CV-Log will be in a high alarm state
- **LOW:** When the CV-Log will be in a low alarm state

8. When everything is set, click on the "✓". That will subscribe the D22 to the selected CV-Log channel. And put it into the following tab.

You can manage the different CV-Log Source/Channel from this tab. You can also configure the interval of the alarm check (minimum possible is 10 minutes) with the input "**Check alarms every**". And decide the combination rule for all the alarm received by the CV-Log's with the box choice "**Combination**".

Two options:

- **OR:** Condition active if at least one CV-Log is in alarm state.
- **AND:** Condition active only if all the CV-Log are in alarm state.

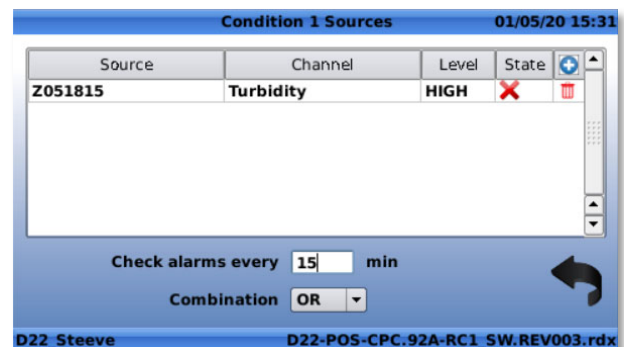

7.9.1.1 Log Files Are no Longer Deleted During an Engine Update

The most recent log files (10 Mb \approx 260 days of data logged) are kept in the internal flash, and no longer deleted after an engine update.

7.9.1.2 Backup Into SD and SD Stockage Improvement

The memories usage, storage and backup has been improved. It is important to know that there are 2 types of memory used: flash memory and SD card.

The flash memory allows you to save all the system configuration and some of the log files.

As for the SD card, it is intended to regularly backup the ValvApps, log files and trace logs (a useful system file used for support if necessary).

The ValvApps, log files and trace logs will be backed-up at each startup and every day at midnight on the SD card. The 10Mb most recent files will be kept on the flash memory, used if an extraction is performed by the user, and the rest will be backed-up into the SD card as follows:

- **ValvApps:** into folder RDX/
- **Log files:** into folder LOG/
- **Trace logs:** into folder TRACE/

The different files are stored into a sub-folder, function of the month and year. See the following example:

/SD/LOG/2020-05/D22-Training-2020-05-04_0800.csv.zip

This makes it easier and faster to navigate through the files.

7.10 SINCE RELEASE 2.8.0 (30.03.2021)

7.10.1 COMPATIBILITY WITH E-LIFT-35 ON THE D12

The D12 is now able to measure signals coming from 0-5 V or 0-10 V sensors (in addition to the already available Ratiometric & 4-20 mA signals). This is especially interesting for connecting the new e-Lift-35 position transmitter to the D12 in 0-10 V mode for a lower power consumption.



IMPORTANT: To use the 0-10 V mode, the D12 needs a resistor in series for a good accuracy. This resistor is provided / included with the e-Lift-35 package. For more detail, please contact CLA-VAL.

The D12 internal switches must be positioned as following:

- **Left for Voltage & Ratiometric sensors**
- **Right for 4-20 mA sensors**

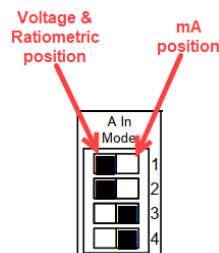

In the software interface:

1. Go into the **"CONFIGURE INPUTS!"** (long click left) > **"AI"**.

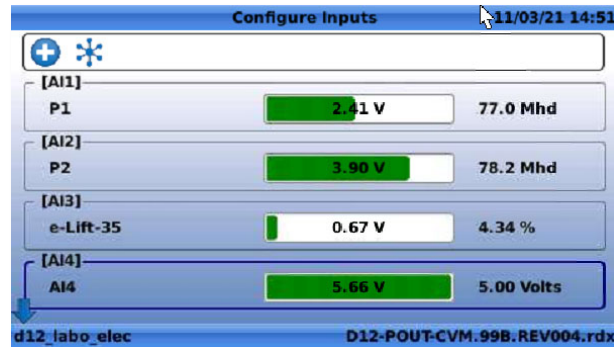

2. Select the correct input and click the left button (short).

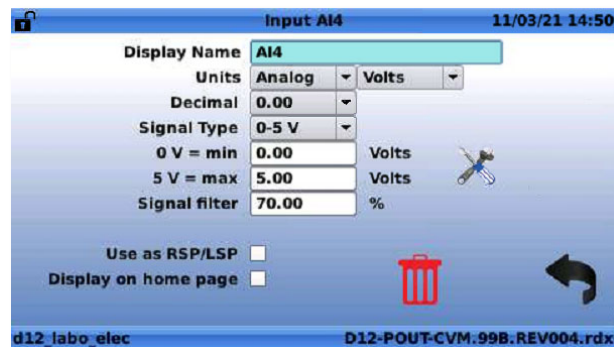

3. Signal Type allows choosing between 4 type of sensor signals:

- 4-20 mA
- Ratio metric
- 0-5 V
- 0-10 V

4. The **"Tool icon"** allows custom scaling & calibration for sensors of type 0-5 V, 0-10 V, or 4-20 mA.

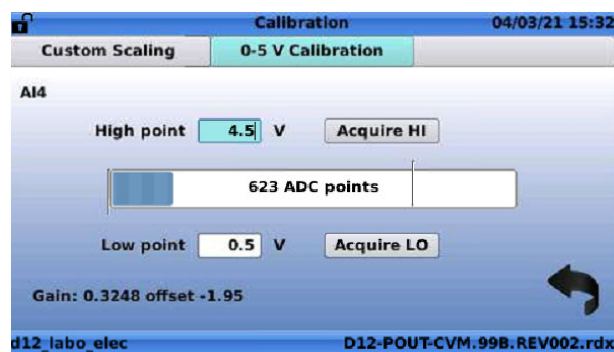

5. For Ratio metric sensors, only the low point needs to be calibrated through the **"Tool icon"**.

7.10.1.1 Custom APN for 4G Communications

Up to now, using a custom SIM card (custom APN and password) was not possible with the new 4G communication. This has now been implemented.

7.10.1.2 WiFi Access Point - Limited Number of Characters

The D12/D22 devices do not support long WiFi network names, therefore a limitation to 31 characters has been implemented for WiFi connections.

7.10.1.3 Special Character "@"

"@" can now be used in the **"Connectivity"** menu (email) and in **"Wizzard"** menu. Up to now, this character was only available in the information / contact.

7.10.1.4 DPM EMEA

Updated DP Metering new table, based on most recent lab measurements.

7.11 SINCE RELEASE 2.8.2 (11.03.2022)

7.11.1 SET LOGGING TIME PRECISELY ON THE D22 & D12

The logging menu now allows setting the logging time precisely, using the **"Offset from midnight"** configuration input. When this setting is 0, the logging cycle starts at midnight, logging once every "Log interval" period. With other offset values, the cycle will start sometime after midnight; for example, a value of 5 min will make the logging cycle start at 00:05.

This feature synchronizes the logging times across devices, which can be useful to compare their data more easily.

To configure this setting through the interface:

1. Go into **"Settings"** (long click down).

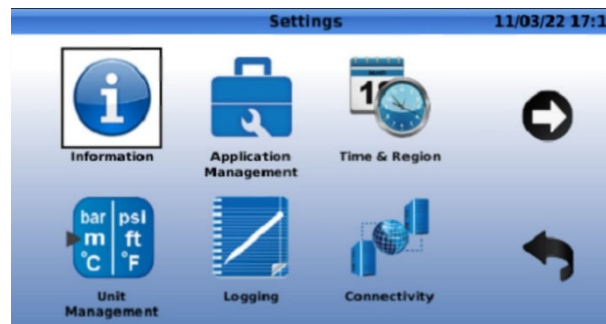

2. Select the **"Logging"** icon then click **"OK"**.



3. Select the **"Configuration"** icon then click **"OK"**.

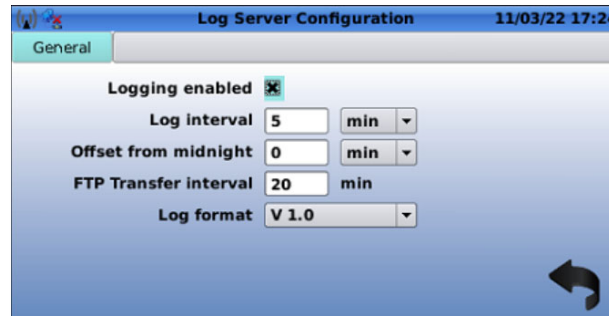

In the example above, with "**Offset from midnight**" set to 0 (the default value), data points will be recorded every 5 minutes from midnight:

- 00h00
- 00h05
- 00h10
- Etc...

7.11.1.1 Fix for SD Card Read / Write Problems

In some cases where read or write access on SD card was not possible, an issue appeared making the device continually reboot. With this update, the procedure has changed to allow devices to boot properly even when the SD card is not accessible.

7.11.1.2 Remote Control Curve Modification Refused when one CC is Off

The D12/D22 devices refused Link2Valves' remote configuration updates when multiple CC were programmed and one of them was set to "**OFF**". With this update, this issue is fixed; CCs can now be configured remotely from Link2Valves with activation set to OFF.

7.12 SINCE RELEASE 2.8.3 (01.10.2022)

7.12.1 ALLOW UPDATE FW TELIT ME910 MODEM 4G FOR D22

A bug has been identified on the Telit ME910 4G Modem that prevents proper data communication on the AT+T network in the USA., a script that can be loaded on a USB key is available, allowing to update the Telit ME910 modem firmware and resolving the issue. The update process takes approximately 2x 50 min, and Telit is working on the next release to update the model faster (date of next release unknown).

This issue only affects **communicating** devices **in the USA**, communicating **through AT+T**.

Here is a step-by-step approach to proceed with the update:

1. Load the script on a USB key
2. Switch the D22/VC-22D off and connect the USB key
3. Switch the D22/VC-22D on and follow
4. Select "Yes" to confirm the firmware update
5. A progression bar will show you when the update is finish.
6. Switch the D22/VC-22D off and on
7. Once the D22/VC-22D completely start up press "long down", select information then version.
8. The new modem version is: **ME910G1-WW: M0C.400004**

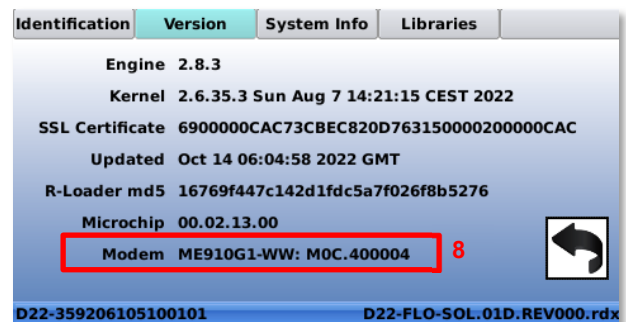
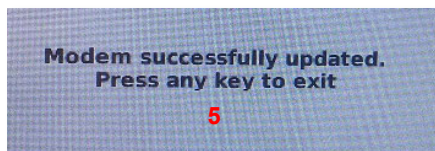
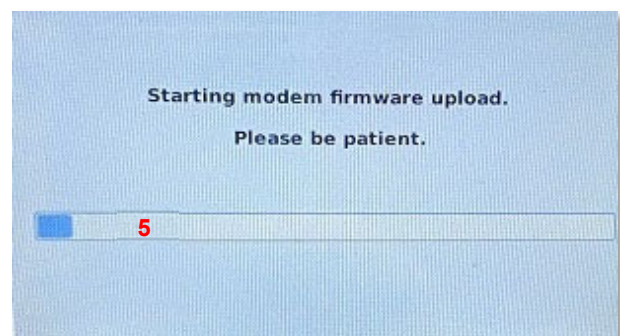
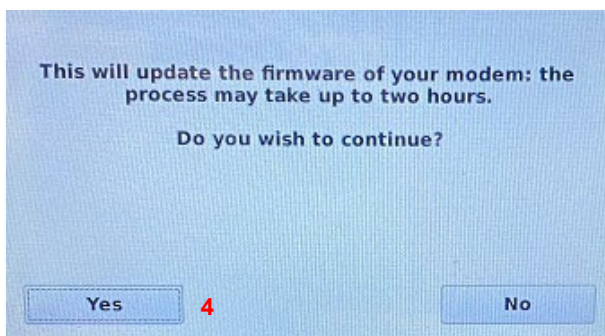

7.1.2.2 UPDATE MICROCHIP (PIC18F86K22 VS. PIC18F87K22)

Due to stock delivery issues, a new microcontroller version was installed on D22/VC-22D devices. The new engine 2.8.3 will automatically update it to version 00.02.13.00

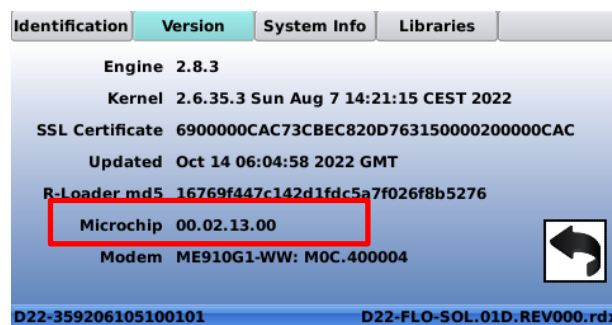

7.12.3 IMPROVED SECURITY

Following a request from the customer Veolia (France), a few system functions have been reviewed and modified for an improved data security (strcpy, strcat, ...).

The version of LFTP (sophisticated file transfer program) has also been updated to 4.9.2

7.12.4 REMOVE "R-ACCESS" USER NAME FROM TEST REPORT

The report of the test bench showed the password of the device. Due to security improvement, we removed the password on the test report automatically generated by the test bench.

7.12.5 MODBUS TCP/IP MENU CLARIFICATION

The text in the Modbus TCP/IP menu has been modified for reasons of misunderstanding. The text changed from "*IEEE Float word order*" into "*Word order 32bits for Modus*".

As a reminder, only words of 32-bit values are concerned by MSW:LSW (**M**ost significant word : **L**east significant Word) order.

Engine 2.8.2 text:

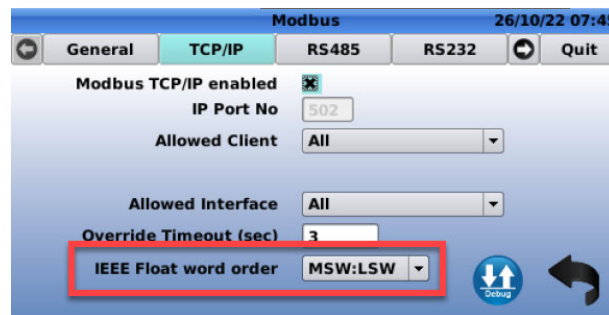

Engine 2.8.3 new text:

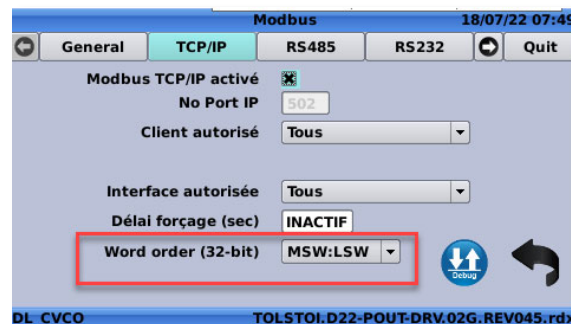

7.12.6 MODBUS OVERRIDE VALUE

When a value was sent through Modbus, the 2 last digits wasn't kept and was rounded to the closest integer number.

Previous Engine (2.8.2) example:

Writing 2225 on 32-bit integer should give a value of 22.25 but was rounded to 22.00 l/s.

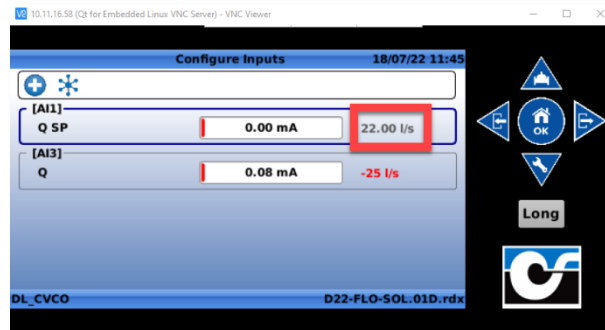
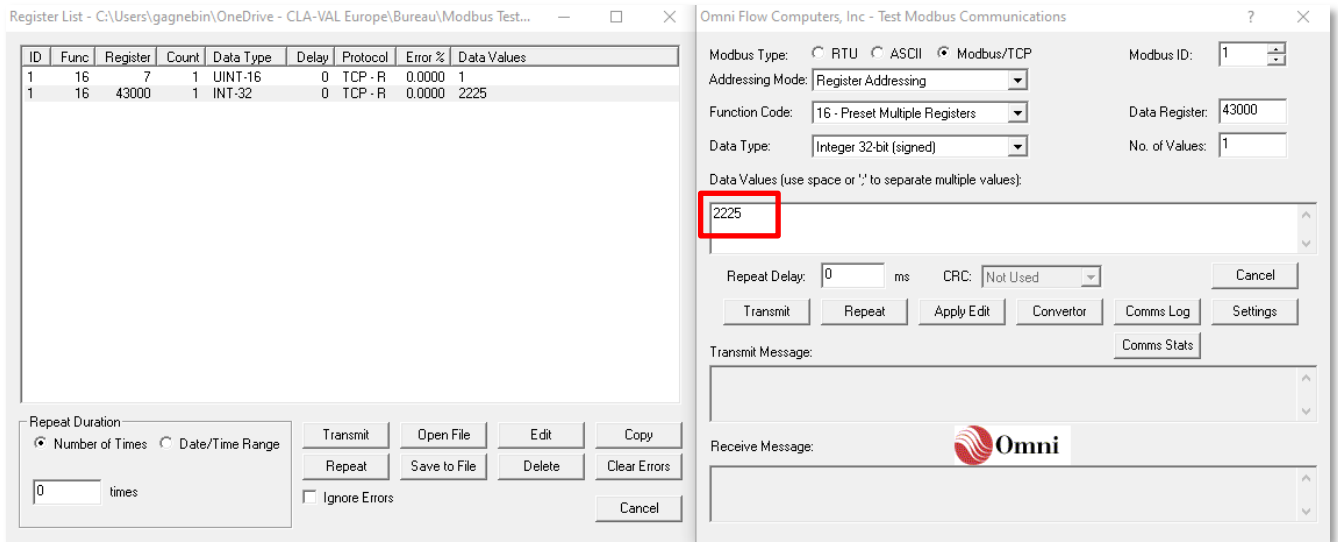

Now the 2 last digits are kept

Engine 2.8.3 example:

Writing 2225 on 32-bit integer will show up 22.25 l/s

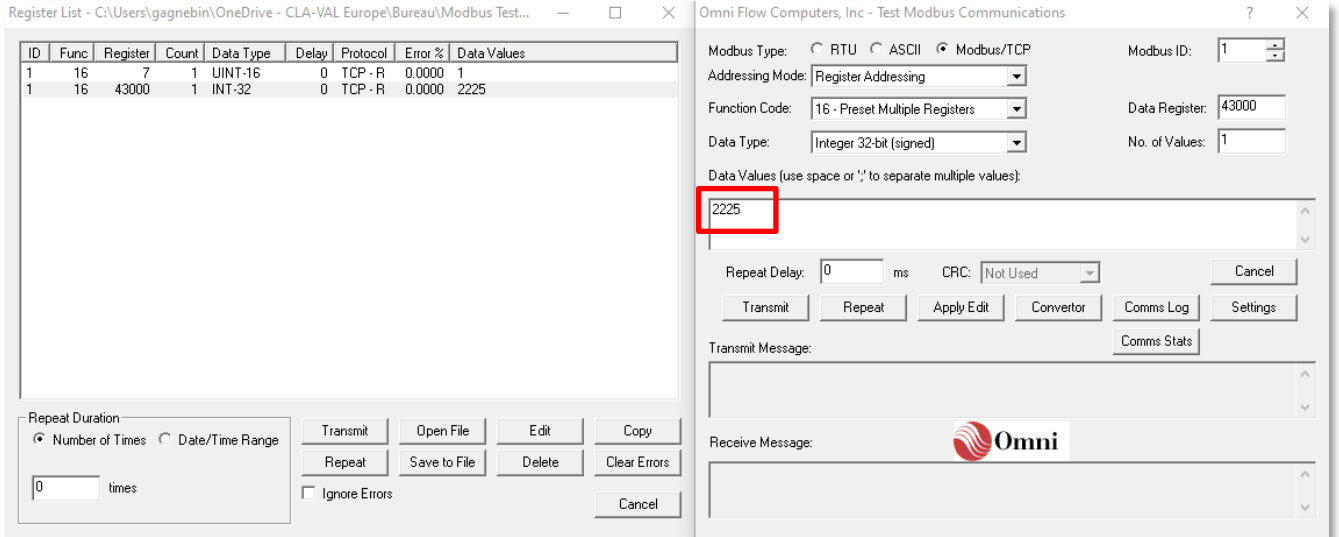

The screenshot shows two windows from the 'Omni Flow Computers, Inc - Test Modbus Communications' software. The left window, 'Register List', contains the following table:

ID	Func	Register	Count	Data Type	Delay	Protocol	Error %	Data Values
1	16	7	1	UINT-16	0	TCP - R	0.0000	1
1	16	43000	1	INT-32	0	TCP - R	0.0000	2225

The right window shows the configuration for Modbus Type: Modbus/TCP, Modbus ID: 1, Addressing Mode: Register Addressing, Function Code: 16 - Preset Multiple Registers, Data Register: 43000, Data Type: Integer 32-bit (signed), and Data Values: 2225. A red box highlights the '2225' value in the Data Values field.

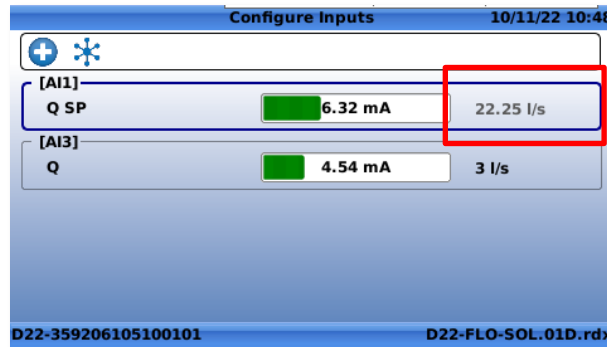

The screenshot shows the 'Configure Inputs' screen with a date/time of 10/11/22 10:48. It displays two input channels:

- [AI1] Q SP: 6.32 mA, 22.25 l/s (highlighted with a red box)
- [AI3] Q: 4.54 mA, 3 l/s

The bottom of the screen shows the device ID 'D22-359206105100101' and the file path 'D22-FLO-SOL.01D.rdx'.

7.12.7 BUG CORRECTIONS

7.12.7.1 Infinite Retres Downloading Remote R-Engine Update

There was a bug when downloading a new R-Engine version via L2V, making the device to get stuck in an infinite restart loop. This is now resolved.

7.12.7.2 Custom Scaling Doesn't Show Decimal Value after Validation

The decimal value of a custom scaling was lost after a reboot of the device. Now, if "Acquire Hi" or "Acquire Lo" is saved on custom scaling with a decimal value, it now keeps the decimal value even after rebooting:

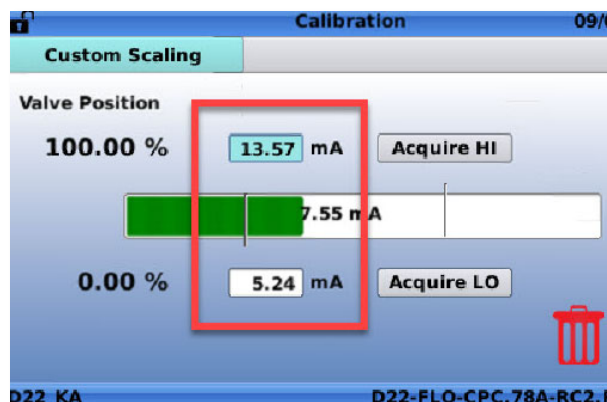

The screenshot shows the 'Calibration' screen with a date/time of 09/0. The 'Custom Scaling' section displays the following values:

- Valve Position: 100.00 %
- 13.57 mA (highlighted with a red box) - Acquire HI
- 7.55 mA
- 0.00 %
- 5.24 mA - Acquire LO

The bottom of the screen shows the device ID 'D22 KA' and the file path 'D22-FLO-CPC.78A-RC2.R'.

7.12.7.3 ValveFlow Calculation with Decimal Value for D12

An optimization of the decimal conversion in the ValveFlow (DPM) calculation has been implemented for the D12 (already implemented on D22 with engine 2.8.2).

7.13 SINCE RELEASE 2.8.4 (17.02.2023)

7.13.1 ALLOW NEGATIVE FLOW VALUE

Some flowmeters have the capability to provide measure reverse flows in addition to straight flows. It is now possible to configure a flow input with a 4-20 mA range including negative values.

4 mA = min	-100	l/s
20 mA = max	100	l/s

7.13.2 LIBRARIES UPDATE

Updated the North American Standard ValvApps library with a new hierarchy folder.

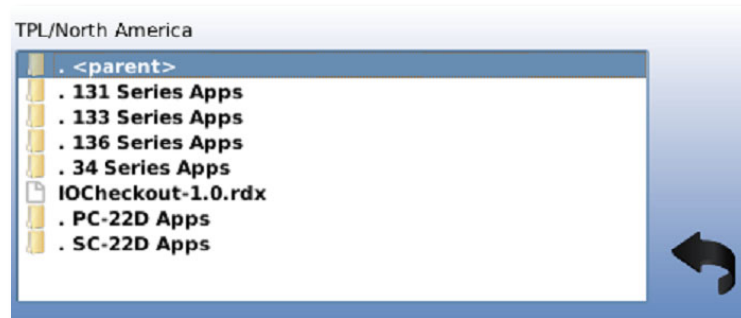

Updated the latest North American DPM table.

7.13.3 BUG CORRECTIONS

7.13.3.1 Multiple Control Curve Points at the Same Time

It was possible to mistakenly create Control Curve points with the same time, creating control issues. This has now been corrected.

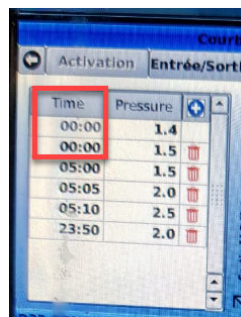

7.13.3.2 Reboot After Removing a Control Curve Point

In some cases, the device could reboot after the modifications of a Control Curve (seen with ValvApps D22-RES-CPC.05E). This issue is now resolved.

7.13.3.3 Bad Formatting of .csv files BY d12/d22 with Engine 2.8.3

The Engine 2.8.3 created bad .csv log files by adding extra "battery charge" columns. This problem is now corrected.

7.14 SINCE RELEASE 2.8.5 (17.08.2023)

7.14.1 MAIN IMPROVEMENTS

7.14.1.1 ValveFlow Improvements (Before DP Metering)

The ValveFlow function has been upgraded with new features, as per the hereafter list.

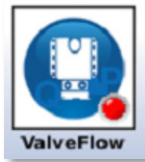

7.14.1.1.1 Valve

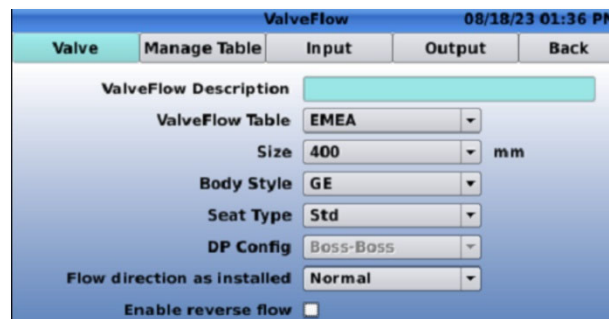

Flow Direction as Installed: Choose **Normal** if the flow through the valve is direct. Select **Reverse** if you are using ValveFlow for reverse flow only.

Enable Reverse Flow: This function allows reading reverse flows when selected. To check if the ValveFlow table includes the Size & Body you have selected, please contact CVEU.

7.14.1.1.2 Manage Table

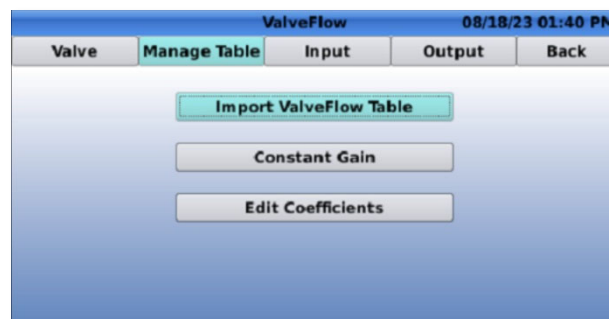

- **Import ValveFlow Table:** A custom ValveFlow table saved from another Valve or generated from new measurements can now be imported.
- **Constant Gain:** A constant gain can be applied to the ValveFlow table to adjust the calculated values.

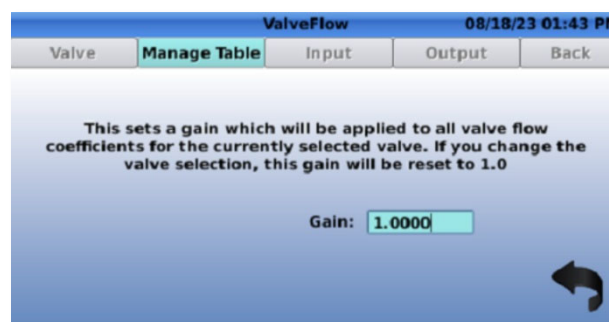

- Edit Coefficients:** Customize the gain applied to the ValveFlow calculation. This can be done in steps of 5%. Manual input is available on the left table. If a Flowmeter is connected to D22 for comparison, automatic calculation can be enabled by selecting the flow input for comparison.

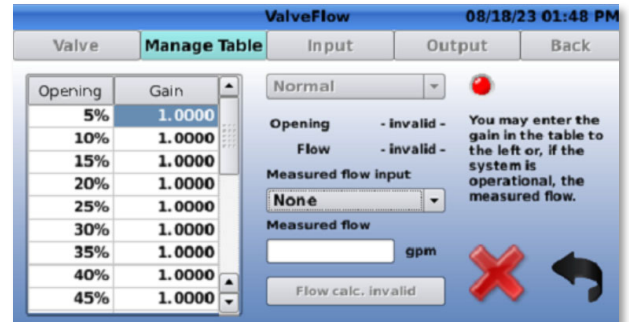
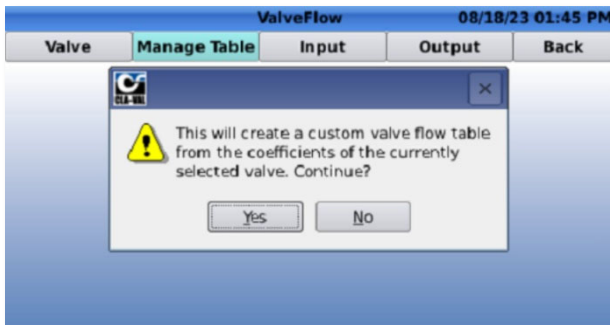

7.14.1.1.3 Output

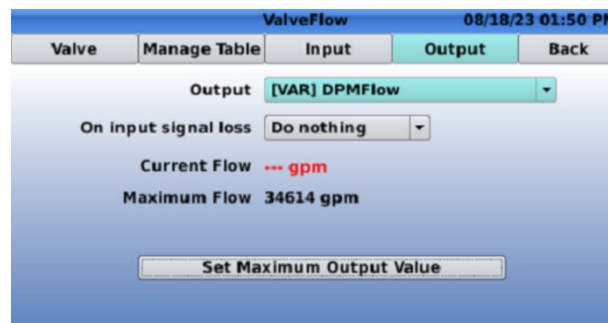

- On Input Signal Loss:** If an input signal used ValveFlow is lost (P1, P2, or Position), the user can select the default behavior of the D22 to be either do nothing or apply a default value.

7.14.1.2 Load Standard ValApps without Factory Reset

You can now upload a new ValvApp directly from the settings menu under **Application Management > Import ValvApp**.

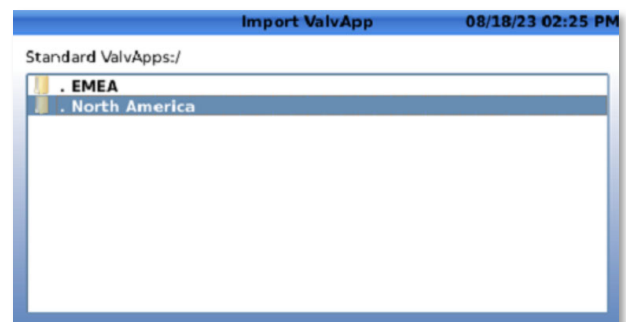
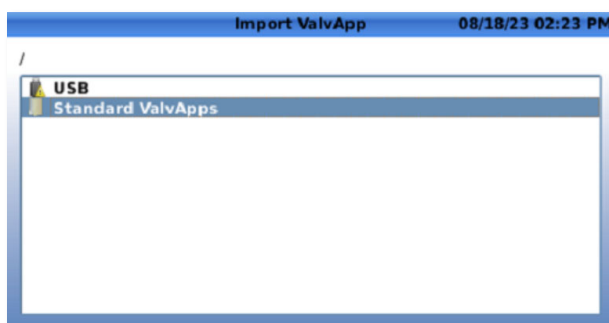

Choose the appropriate folder for your region (EMEA for Europe & Middle East / North America for the US).

7.14.1.3 Add Totalizer via the Configuration Menu

The totalizer functionality is now always available without the need for a specific ValvApps. In the **Valve** Menu (accessible by holding the 'up' button from the home screen), a Totalizer can be added on the fly (up to 4 totalizers are possible).

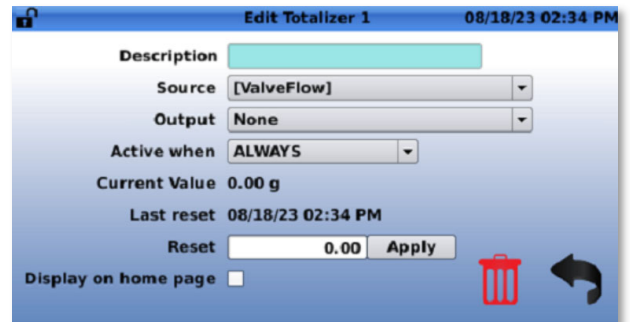

7.14.1.4 Add New Outputs on the Fly

From the home screen menu, holding the right button gives access to the configuration menu. Outputs not defined by default in the ValvApps can now be added. Select the  icon and then click "OK" to see the available outputs.

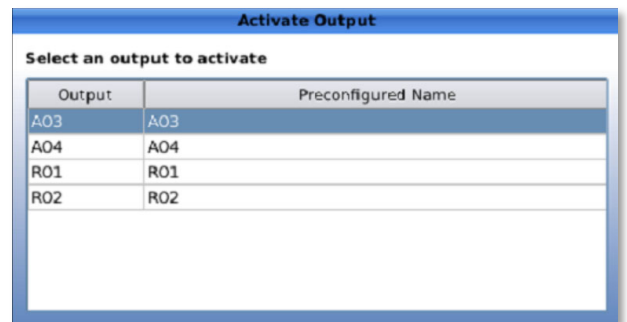
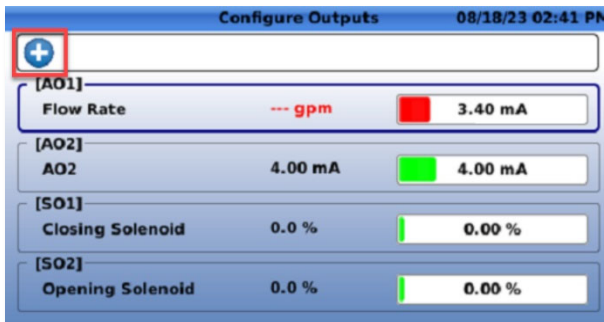

After selecting the desired output, it will appear in "Configure Outputs", where you can proceed with further configuration (units, range, etc.) and use it for actions or other options.

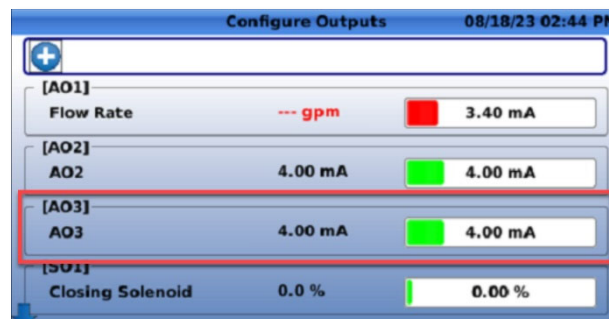

7.14.2 BUG CORRECTIONS

7.14.2.1 Prevent Register if e-Mail Field is Invalid

A popup message will appear if the email is not valid or not provided.



7.14.2.2 GSM Signal Strength Measures Stuck at 0 (D12 only)

In the log files sent by the D12, the modem receives irregular characters in the operator's name, in addition to losing the ability to measure GSM strength. Version 2.8.5 fixes this issue and restores GSM strength measurements.

7.14.2.3 Control Curves Round Output to Whole Number when Using 2 Decimals

A bug can appear in previous versions of the R-Engine, when adding a control curve using a Variable output with 2-decimal precision:

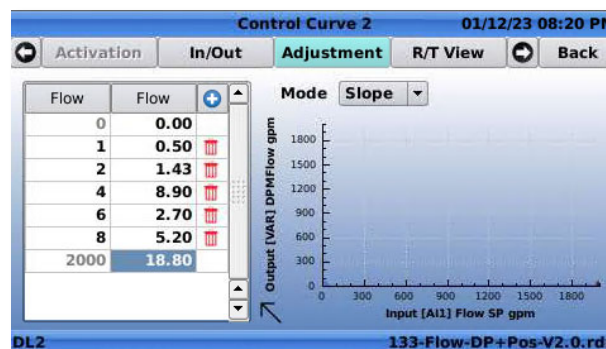

Leaving and going back to the Control Curve menu would display a *nan* value, or decimals would be lost.

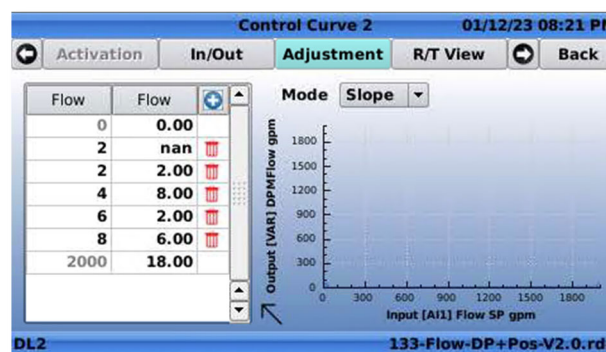

Version 2.8.5 fixes this issue and maintains the original precision.

7.14.2.4 Fix for Slow Network FTP Communication

It has been noticed that some networks can be slower, causing issues with FTP communications. Version 2.8.5 corrects these issues this by improving timeout controls.

7.15 SINCE RELEASE 2.8.6 (25.04.24)

7.15.1 NEW FEATURES

7.15.1.1 Modbus Log-to-Disc

This feature allows users to easily save and access Modbus debugging logs on external devices. It provides a more efficient way to troubleshoot Modbus issues. It eliminates the inconvenience of navigating and troubleshooting Modbus on the controller's screen. Additionally, users can continue navigating on the controller while the debugging logs are being saved in the background.

When clicking on any Modbus debug button (TCP/IP, RS485, or RS 232), if a USB stick is connected to the D22, the following message will appear:



If the debugging tab is closed, then a pop-up message will appear which asks if the logging on the USB key should continue.

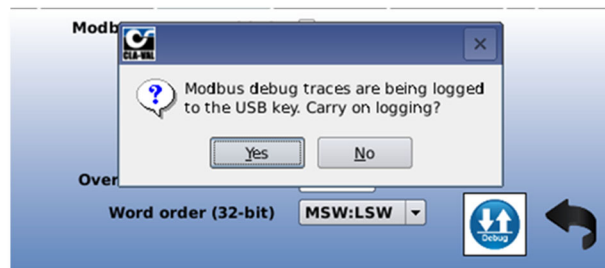

By choosing "Yes", the logging to the USB stick will continue until it is disabled, USB stick is full, USB stick is removed or the D22 is rebooted.

The logged data will be displayed in the same format like on the Debug window of the D22 controller. While the logging into the USB stick is active, the Modbus icon on the home page header will show a little red icon:

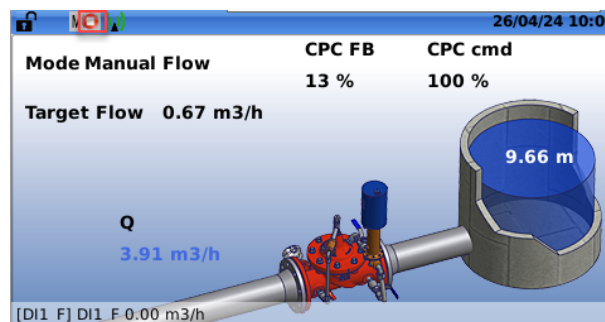

7.15.1.2 R-loader Access from Advanced Settings Menu

R-loader serves as an advanced troubleshooting tool. It can be accessed during the controller startup by holding down both side buttons. With this new version, users will have the possibility to access this tool directly from the advanced settings menu.

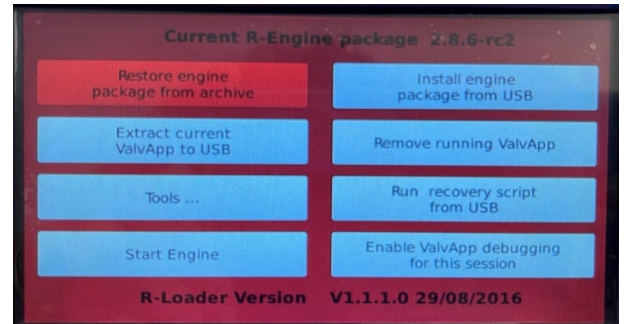

The usage of the R-Loader might change factory parameters. It is strongly recommended to ask assistance from the factory when using this feature.

7.15.2 IMPROVEMENTS

7.15.2.1 Cellular Network

The cellular network window has been upgraded with new features, and its icon name has changed.

7.15.2.1.1 Icon Name

The icon name passed from "GPRS/GSM" to "Modem".

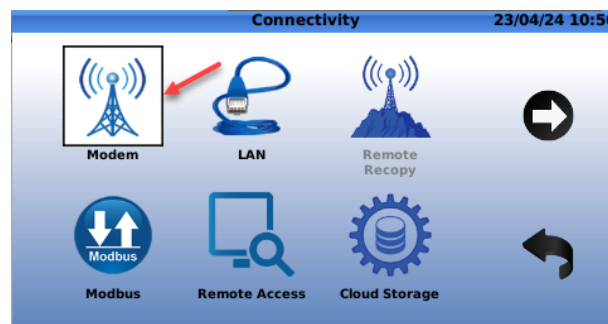

7.15.2.1.2 Network

The following image shows the modifications that have been made on the Network tab inside the Modem:

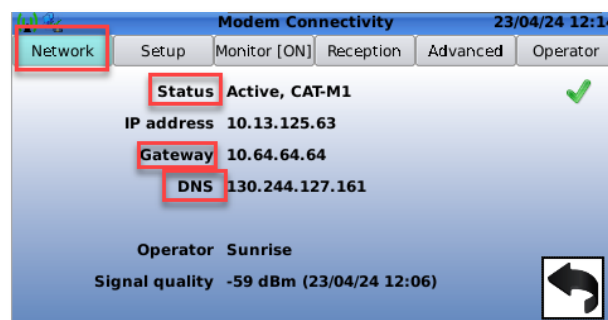

7.15.2.1.3 Setup

The tab name “GPRS Setup” has changed to “Setup”. In addition to this modification, an additional option has been added to the tab which allows to choose the **4G connection technology**.



4G connection technology: Offers the possibility to choose between numerous options of communication depending on the coverage constraints, and the geographical situation of the device.

7.15.2.2 E-Drive Menu

The navigation for setting up and calibrating an E-Drive has been enhanced by adding additional buttons on certain tabs. This improvement allows for smoother calibration processes and more efficient adjustments.

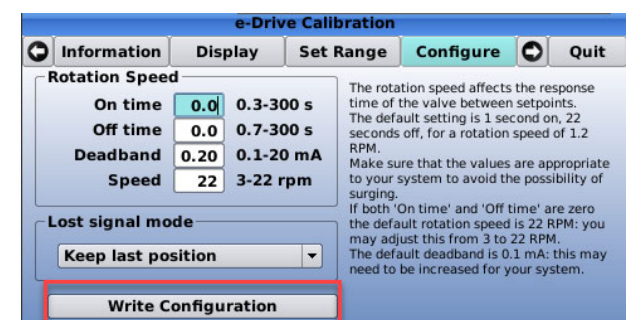
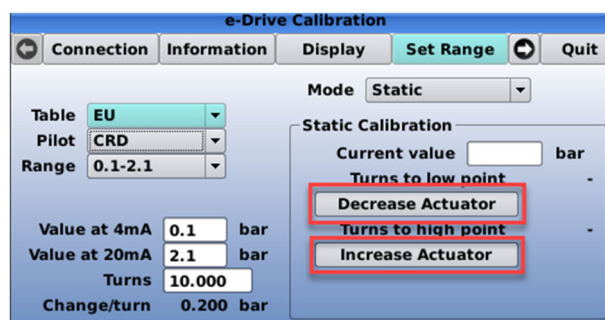
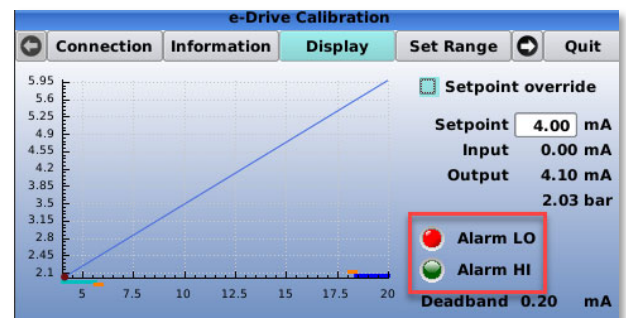
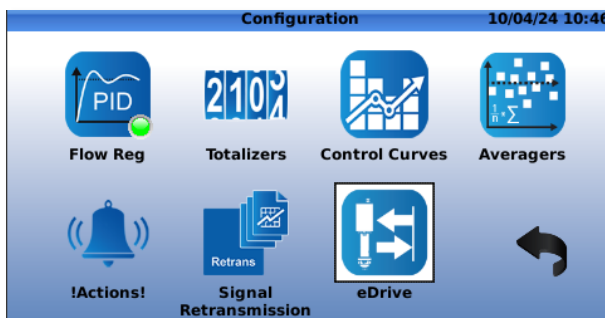

7.15.2.3 Options for Handling Signal Losses on DI_F

This enhancement provides users with the option to select a value in the event of no signal on a digital frequency input, offering greater flexibility and control.

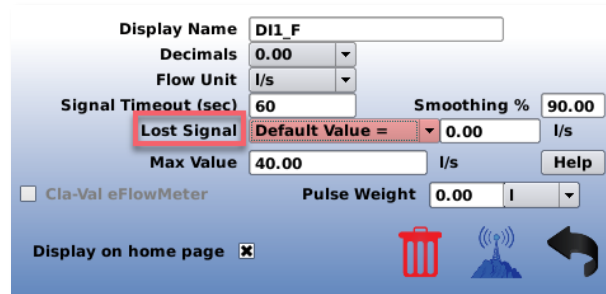

It is possible to choose a default value, to keep the existing value or do nothing in case there is a lost signal on this type of input.

7.15.3 BUG FIXES

- The issue where control curve modifications made on L2V weren't applying to the controller was resolved. With this version, adjustments can be made on L2V and applied to the controller without problem.
- No need to restart the device after switching between the Modbus tables.
- In the ValvApps that include ValFlow (DPMetering) the PID will continue to control the valve in case of no signal on certain inputs.